



swiss bed concept



BERGAMO

MASSIVHOLZ | BOIS MASSIF | SOLID WOOD

Achten Sie auf FSC®-zertifizierte Produkte | Soyez attentifs aux produits certifiés FSC® | Look for FSC®-certified products



Hasena – mein Bett

Hasena – mon lit | Hasena – my bed

Beständige Passion

Une passion constante
Enduring Passion

Mehr als ein Lebenswerk

Seit 1951 überzeugen wir mit hoher Qualität und Vielseitigkeit im Bereich Schlafzimmermöbel.

Plus que l'œuvre d'une vie

Depuis 1951, nous convainquons par notre qualité élevée et notre polyvalence dans le domaine des meubles de chambre à coucher.

More than a life's work

Since 1951 we have been convincing with high quality and versatility in the bedroom furniture sector.



swiss bed concept



swiss bed concept

Ein cleveres Baukastensystem

Sie wählen Ihren favorisierten Bettrahmen aus und kombinieren dazu Füße und Kopfteil Ihrer Wahl. Dabei können Sie quer durch die Kollektionen auf unterschiedliche Materialien und Farben zugreifen.

Un système modulaire astucieux

Choisissez votre cadre de lit préféré et combinez-le avec les pieds et la tête de lit de votre choix. Vous pouvez choisir parmi une variété de matériaux et de couleurs dans toutes les collections.

A clever modular system

You choose your favourite bed frame and combine it with the feet and headboard of your choice. You can choose from a variety of materials and colours throughout the collections.

5 Jahre Garantie

5 ans de garantie
5 years warranty



Unser Versprechen

Vom Baum zum Bett – mittels handwerklicher Perfektion und hochwertigen Materialien. Sie erhalten 5 Jahre Garantie auf die Material- und Oberflächenbeschaffenheit, sowie die fachgerechte Verarbeitung aller Modelle ab Kaufdatum. Weitere Informationen finden Sie auf unserer Website.

Notre promesse

De l'arbre au lit – grâce à un artisanat parfait et des matériaux de haute qualité. Vous bénéficiez d'une garantie de 5 ans sur la qualité des matériaux et des surfaces, ainsi que sur la fabrication professionnelle de tous les modèles à compter de la date d'achat. Vous trouverez plus d'informations sur notre site Internet.

Our promise

From tree to bed – by means of perfect craftsmanship and high-quality materials. You receive a 5-year guarantee on the material and surface quality, as well as the professional workmanship of all models from the date of purchase. Further information can be found on our website.

Schnellieferservice

Service de livraison rapide
Quick delivery service



Komfort ohne Wartezeit

Mit unserem Schnellieferservice «PRONTO» können wir eine grosse Auswahl an Betten mit Beimöbeln und alle Modelle aus Edition pronto, Dream pronto und Boxspring pronto ab Lager liefern.

Le confort sans délai d'attente

Notre service de livraison rapide « PRONTO » permet de livrer un large choix de lits, de meubles d'appoint et tous les modèles de l'Édition Pronto, Dream pronto et Boxspring Pronto à partir du stock.

Comfort without waiting

With our „PRONTO“ fast delivery service, we can deliver a large selection of beds with ancillary furniture and all models from Edition pronto, Dream pronto and Boxspring pronto from stock.



Vielseitig kombinierbar

Unser ausgeklügeltes Baukastensystem «swiss bed concept» bietet eine riesige Auswahl an Füßen, Kopfteilen und Beimöbeln. Darüber hinaus umfasst es verschiedene Stoff-, Kunstleder- und Lederbezüge sowie diverse Holz- und Metallausführungen. Abgestimmte Lattenroste und Matratzen komplettieren unsere Betten zur Wohlfühloase.

Combinable à souhait

Notre système modulaire sophistiqué «swiss bed concept» propose un large choix de pieds, têtes de lits et accessoires. Par ailleurs il comporte différents tissus, cuirs synthétiques et véritables, ainsi que diverses variantes de bois et métal. Des sommiers à lattes et des matelas adaptés complètent nos lits pour un espace bien-être.

Versatile combinable

Our ingenious modular system «swiss bed concept» offers a huge selection of feet, headboards and accessories. In addition, it includes different fabrics, synthetic leather and real leather covers and different wood and metal versions. Matching slatted frames and mattresses complete our beds to an oasis of well-being.



Stabil im Aufbau

Unsere Betten überzeugen durch eine hohe Stabilität. Mittels Einsatz verschiedener Traversen ist eine gesamthafte Belastung von 300 bis 450 kg, inklusive Lattenroste und Matratzen, möglich.

Construction robuste

Nos lits sont convaincants par leur grande stabilité. En utilisant différentes traverses, une charge totale de 300 à 450 kg, y compris sommiers et matelas, est possible.

Solid in construction

Our beds convince with their high stability. By using different trusses, a total load of 300 to 450 kg, including slatted frames and mattresses, is possible.



Einfach in der Montage

Unser Betten-System begeistert durch einen einfachen Aufbau mit leicht verständlicher Montageanleitung sowie hochwertigen Verbindungselementen, welche einen vielfachen Ab- und Wiederaufbau ermöglichen.

Montage facile

Notre système de lits séduit par un montage facile grâce aux instructions aisément compréhensibles ainsi que par les éléments de fixation haut de gamme permettant de monter et démonter les lits à de nombreuses reprises.

Easy to install

Our bed system impresses with its simple, easy-to-understand assembly instructions and high-quality connecting elements, which enable multiple dismantling and reassembly.

Nachhaltigkeit bei Hasena

Unser wichtigster Lieferant, die Natur, ist sensibel und benötigt lange Regenerationszeiten bei Überbeanspruchung. Wir respektieren die von uns genutzten Ökosysteme und stellen unsere Produkte nachhaltig und mit hohem sozialen Engagement her.

Durabilité chez Hasena

Notre fournisseur le plus important, la nature, est sensible et nécessite un long temps de régénération en cas de surutilisation. Nous respectons les écosystèmes que nous utilisons et fabriquons nos produits de manière durable et avec un haut niveau d'engagement social.

Sustainability at Hasena

Our most important supplier, nature, is sensitive and needs long regeneration times in case of overuse. We respect the ecosystems we use and manufacture our products sustainably and with a high level of social commitment.



Soziale Verantwortung

Responsabilité sociale
Social responsibility



Holzbeschaffung

Approvisionnement en bois
Wood procurement



Produktion Massivholz

Production bois massif
Manufacturing solid wood



Holzoberflächen

Surfaces en bois
Wood surfaces



Recycelte Stoffe

Tissus recyclés
Recycled fabrics



Energiegewinnung

Production énergétique
Production of energy



Mehr über Hasena
En savoir plus sur Hasena
More about Hasena

Bettrahmen | Cadre de lit | Bedframe



Bergamo 3S



Breiten | Largeurs | Widths:
140, 160, 180, 200 cm

Längen | Longueurs | Lengths:
200, 210 cm

Bergamo 4S



Breiten | Largeurs | Widths:
90, 100, 120, 140, 160, 180, 200 cm

Längen | Longueurs | Lengths:
200, 210 cm

Traversen | Traverses | Bars

Wir empfehlen grundsätzlich den Einsatz von Crosstraver (Quertraverse) oder Midtraver (Längstraverse).
Nous recommandons en général l'utilisation de Crosstraver (traverse transversale) ou Midtraver (traverse centrale).
We recommend basically the insertion of Crosstraver (central cross bar) or Midtraver (central bar).

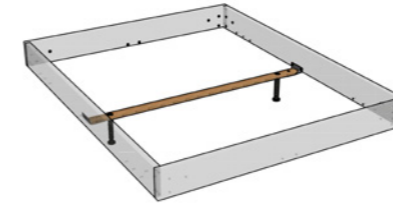

Crosstraver
Quertraverse | Traverse transversale | Central cross bar

Für alle Bettbreiten | Pour toutes les largeurs de lit | For all bed widths

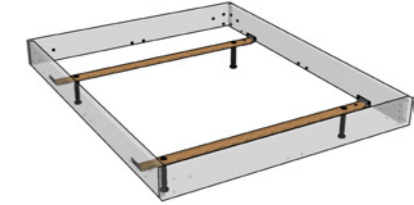

Crosstraver-Twin
Quertraversen | Traverses transversales | Cross bars

Für alle Bettbreiten | Pour toutes les largeurs de lit | For all bed widths

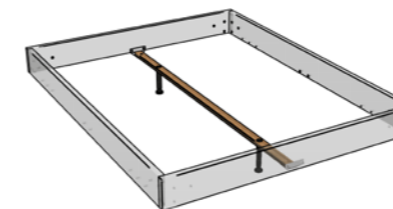

Midtraver
Längstraverse | Traverse centrale | Central bar

Für Betten ab Breite 140 cm mit 2 Lattenrosten oder Motorrahmen-einbau | Pour les lits à partir de 140 cm de largeur avec 2 sommiers ou l'installation d'un cadre motorisé | For beds from 140 cm width with 2 slats or motor frame installation

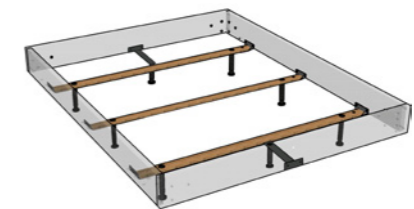

Crosstraver-XXL
Quertraversen | Traverses transversales | Cross bars

Für alle Bettbreiten | Pour toutes les largeurs de lit | For all bed widths

Holz | Bois | Wood



80 Kernbuche natur, geölt
Hêtre cœur rouge naturel, huilé
Heart beech natural, oiled

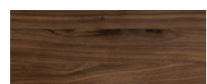

82 Nussbaum, geölt
Noyer, huilé
Walnut, oiled

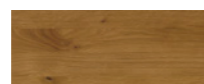

99 Wildeiche natur, geölt
Chêne nouveau naturel, huilé
Wildoak natural, oiled



Füsse | Pieds | Feet



Holz Bois Wood	Masse cm Dim. cm	Breiten cm Largeurs cm Widths cm	Höhen cm Hauteurs cm Heights cm		Holzfarben Couleurs bois Colours wood		
			20	25	80	82	99
Lana	8 x 5		•	•	•	•	•
Nelo			•	•	•	•	•
*Delo 2er Set set de 2 set of 2			•	•	•	•	•
Tunca	8 x 8		•	•	•	•	•

* bei Kopfteilen Cloe und Samira Delo 2er Set | pour les têtes de lit Cloe et Samira Delo set de 2 pièces | for headboards Cloe and Samira Delo set of 2

Metall Métal Metal	Masse cm Dim. cm	Breiten cm Largeurs cm Widths cm	Höhen cm Hauteurs cm Heights cm		Metallfarben Couleurs métal Colours metal		
			20	25	16	42	45
Roca	6 x 6		•	•	•	•	•
Tondo			•	•	•	•	•
*Fundo 2er Set set de 2 set of 2			•	•	•	•	•
Glyd	2 x 6	140–200	•	•	•	•	•

* bei Kopfteilen Cloe und Samira Fundo 2er Set | pour les têtes de lit Cloe et Samira Fundo set de 2 pièces | for headboards Cloe and Samira Fundo set of 2

Holz | Bois | Wood

Metall | Métal | Metal

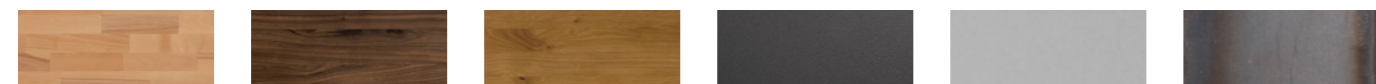

- 80 Kernbuche natur, geölt**
Hêtre cœur rouge naturel, huilé
Heart beech natural, oiled
- 82 Nussbaum, geölt**
Noyer, huilé
Walnut, oiled
- 99 Wildeiche natur, geölt**
Chêne nouveau naturel, huilé
Wildoak natural, oiled
- 16 Anthracit**
- 42 Alu**
- 45 Iron**



Bettkasten | Coffres à literie | Bedding boxes

Practico-Box + Ultrafree-Lift KF



Practico-Box + Econom-move



Ultrafree-Lift KF



Econom-move



Stauraum | Compartiment de rangement | Storage space

90 × 200/210	=	81 × 190/200 × 24 cm
100 × 200/210	=	91 × 190/200 × 24 cm
120 × 200/210	=	111 × 190/200 × 24 cm
140 × 200/210	=	131 × 190/200 × 24 cm
160 × 200/210	=	74 × 190/200 × 24 (2 x) cm
180 × 200/210	=	84 × 190/200 × 24 (2 x) cm
200 × 200/210	=	94 × 190/200 × 24 (2 x) cm

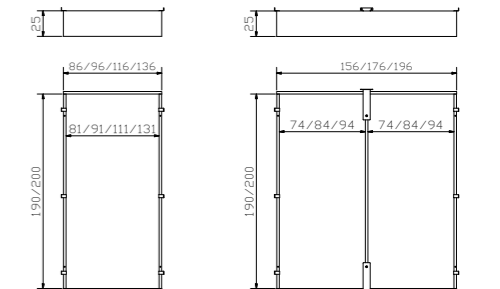

Weitere Informationen zu unseren Lattenrosten finden Sie unter www.hasenabeds.com | Vous trouverez de plus amples informations sur nos sommiers à lattes sur www.hasenabeds.com | Further information about our slatted frames can be found at www.hasenabeds.com

Holz | Bois | Wood

Breiten cm Largeurs cm Widths cm	Höhen cm Hauteurs cm Heights cm				Holzfarben Couleurs bois Colours wood							
	10	20	25	30	06	07	09	10	16	74	76	80
Practico-Box (inkl. Boden fond inclus bottom included)	90–200		•					•	•			•

Practico-Box aus Spanplatte mit Folie bezogen. | Practico-Box en panneau de particules recouvert d'un feuillet. | Practico-Box made of chipboard covered with foil.

Roll-Box 20/25



Bettkasten in weiss oder anthrazit

Voraussetzung

Bettfusshöhe von mindestens 20 cm erforderlich

Optionen

Deckel Covero in weiss, Stoffabdeckung Saceto in Polyester grau

Hinweis: Ausführung Wildeiche 93 ist gebürstet.

Roll-Box 20/25 + Covero



Tiroir de lit en blanc ou anthracite

Condition préalable

Une hauteur de pieds de lit d'au moins 20 cm est nécessaire

Options

Couvercle Covero en blanc, tissu de protection Saceto en polyester gris

Remarque: La finition Chêne nouveau 93 est brossé.

Roll-Box 20/25 + Saceto



Bed drawer in white or anthracite

Condition

Feet of bed need a minimum height of 20 cm

Options

Covero in white, tissue of protection Saceto in polyester grey

Note: Wild oak 93 version is brushed.



Roll-Box 20

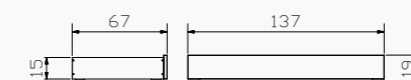

Roll-Box 25



Stauraum | Espace de rangement | Storage space

Roll-Box 20	=	134 × 61 × 13 cm
Roll-Box 25	=	134 × 61 × 16 cm

Kopfteile für Bettrahmen 3S | Têtes de lit pour cadre 3S | Headboards for frame 3S



Dimension 140, 160, 180 cm

Stoffauswahl | Choix de tissus | Choice of fabrics
Pronto: 327 Pepe beige, 335 Pepe grey, 720 Buffalo shale, 721 Buffalo grey, 722 Buffalo espresso

Kat./Cat. 3: —
 Kat./Cat. 4: —



Dimension 140, 160, 180, 200 cm

Stoffauswahl | Choix de tissus | Choice of fabrics
Pronto: —
 Kat./Cat. 3: komplett/complet/complete
 Kat./Cat. 4: —



Dimension 140, 160, 180 cm

Stoffauswahl | Choix de tissus | Choice of fabrics
Pronto: 327 Pepe beige, 323 Kul white, 335 Pepe grey, 336 Kul smoke, 720 Buffalo shale

Kat./Cat. 3: —
 Kat./Cat. 4: —



Dimension 140, 160, 180, 200 cm

Stoffauswahl | Choix de tissus | Choice of fabrics
Pronto: —
 Kat./Cat. 3: komplett/complet/complete
 Kat./Cat. 4: —

Kopfteile für Bettrahmen 4S | Têtes de lit pour cadre 4S | Headboards for frame 4S



Dimension 90/100, 120, 140, 160, 180/200 cm

Stoffauswahl | Choix de tissus | Choice of fabrics
Pronto: 323 Kul white, 335 Pepe grey, 336 Kul smoke

Kat./Cat. 3: komplett/complet/complete
 Kat./Cat. 4: —



Dimension 140, 160, 180, 200 cm

Stoffauswahl | Choix de tissus | Choice of fabrics
Pronto: —
 Kat./Cat. 3: komplett/complet/complete
 Kat./Cat. 4: komplett/complet/complete



Dimension 90, 100, 120, 140, 160, 180, 200 cm

Stoffauswahl | Choix de tissus | Choice of fabrics
Pronto: 323 Kul white, 335 Pepe grey, 336 Kul smoke

Kat./Cat. 3: ✓ - ohne/sans/without Boston
 Kat./Cat. 4: ✓ - ohne/sans/without Vintage

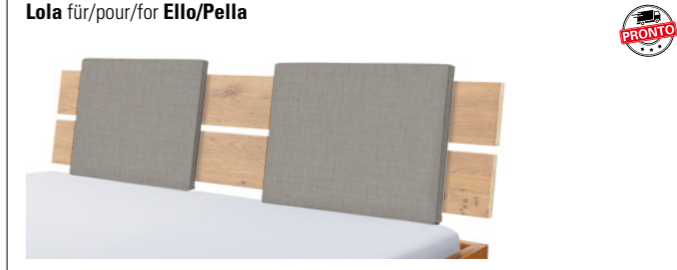

Dimension 140, 160, 180/200 cm
 Kissen 55x35x4 cm

Stoffauswahl | Choix de tissus | Choice of fabrics
Pronto: 323 Kul white, 335 Pepe grey, 336 Kul smoke
 Kat./Cat. 3: —
 Kat./Cat. 4: —

* ab Bettrahmenoberkante | à partir du bord supérieur du cadre de lit | from top edge of bed frame
 ** ab Boden | à partir du sol | from the floor

* ab Bettrahmenoberkante | à partir du bord supérieur du cadre de lit | from top edge of bed frame

Stoffauswahl Choix de tissus Selection of tissues	Pronto			Pronto				Stoffkategorie Catégorie de tissu Fabric category	
	720	721	722	323	327	335	336	Kat./Cat. 3	Kat./Cat. 4
Sofia	•	•	•						
Jaro	•			•	•	•	•		
Samira								•	
Cloe								•	
Lecco				•		•	•	•	
Boga				•		•	•	▲	▲
Amy								•	•
Lola für/pour/for Ello/Pella				•		•	•		

▲ Kat./Cat. 3 ohne/sans/without Boston - Kat./Cat. 4 ohne/sans/without Vintage



Stoff- und Lederauswahl siehe Katalog Seite 1.6/1.7 oder auf der Hasena Website
 Choix de tissus et cuirs voir le catalogue page 1.6/1.7 ou sur le site internet Hasena
 Choice of fabrics and leathers see catalogue page 1.6/1.7 or on the Hasena website

Kopfteile für Bettrahmen 4S | Têtes de lit pour cadre 4S | Headboards for frame 4S



Elo



Dimension 96, 126, 146, 166, 186 cm

Turano**



Dimension 140, 160, 180/200 cm

Pella



Dimension 90/100, 120, 140, 160, 180/200 cm

Montello



Dimension 90/100, 120, 140, 160, 180/200 cm

* ab Bettrahmenoberkante | à partir du bord supérieur du cadre de lit | from top edge of bed frame

** Turano nicht in 80 Kernbuche natur, geölt erhältlich | Turano non disponible en 80 Hêtre cœur rouge naturel, huilé | Turano not available in 80 heart beech natural, oiled

Holz | Bois | Wood



- 80 Kernbuche natur, geölt**
Hêtre cœur rouge naturel, huilé
Heart beech natural, oiled
- 82 Nussbaum, geölt**
Noyer, huilé
Walnut, oiled
- 99 Wildeiche natur, geölt**
Chêne nouveau naturel, huilé
Wildoak natural, oiled



Adapter | Adaptateur | Adapter

Bei hohen Matratzen kann mit dem Verlängerungsadapter das Kopfteil um 9 oder 13 cm erhöht werden. | La tête de lit peut être rehaussée de 9 ou 13 cm avec l'adaptateur quand le matelas est plus épais. | With the extension adapter the headboard can be extended 9 or 13 cm if mattresses are high.

Head-Plus

Metal | Métal | Metal

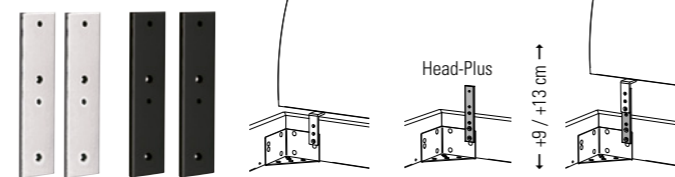

alu black

Holz | Bois | Wood

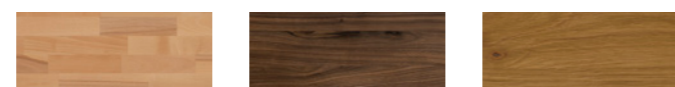

- 80 Kernbuche natur, geölt**
Hêtre cœur rouge naturel, huilé
Heart beech natural, oiled
- 82 Nussbaum, geölt**
Noyer, huilé
Walnut, oiled
- 93 Wildeiche natur, gebürstet, geölt**
Chêne nouveau naturel, brossé, huilé
Wildoak natural, brushed, oiled



Metal | Métal | Metal



16 Anthracit 42 Alu 45 Iron

Herrendiener | Valet | Dressboy

Claudio

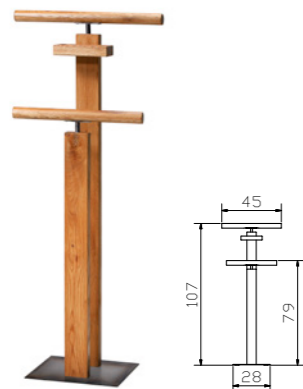

Hinweis: Ausführung Wildeiche 93 ist gebürstet.
Remarque : La finition Chêne nouveau 93 est brossé.
Note: Wild oak 93 version is brushed.

Nachttische | Tables de nuit | Bedside tables



Akai

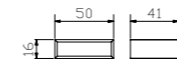

Salva



Jaca



Jose

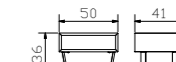

Holz | Bois | Wood

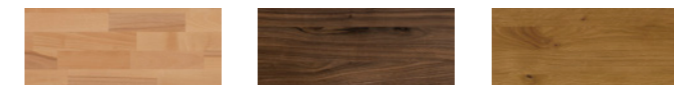

- 80 Kernbuche natur, geölt**
Hêtre cœur rouge naturel, huilé
Heart beech natural, oiled
- 82 Nussbaum, geölt**
Noyer, huilé
Walnut, oiled
- 99 Wildeiche natur, geölt**
Chêne nouveau naturel, huilé
Wildoak natural, oiled



Bettkasten | Coffre à literie | Bedding box

Roll-Box 20/25



Bettkasten in weiss oder anthrazit

Voraussetzung

Bettfussshöhe von mindestens 20 cm erforderlich

Optionen

Deckel Covero in weiss, Stoffabdeckung Saceto in Polyester grau

Hinweis: Ausführung Wildeiche 93 ist gebürstet.

Roll-Box 20/25 + Covero



Tiroir de lit en blanc ou anthracite

Condition préalable

Une hauteur de pieds de lit d'au moins 20 cm est nécessaire

Options

Couvercle Covero en blanc, tissu de protection Saceto en polyester gris

Remarque : La finition Chêne nouveau 93 est brossé.

Roll-Box 20/25 + Saceto



Bed drawer in white or anthracite

Condition

Feet of bed need a minimum height of 20 cm

Options

Covero Covero in white, tissue of protection Saceto in polyester grey

Note: Wild oak 93 version is brushed.

Ausführungen für Bettkasten-Front | Exécutions pour façades coffres à literie | Executions for fronts of bedding box

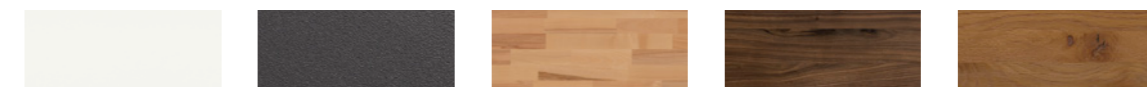

10 Weiss deckend, lackiert
Blanc couvrant, laqué
White covered, lacquered



16 Buche anthracit deckend, lackiert
Hêtre teinté anthracite couvrant, laqué
Beech anthracite covered, lacquered



80 Kernbuche natur, geölt
Hêtre cœur rouge naturel, huilé
Heart beech natural, oiled



82 Nussbaum, geölt
Noyer, huilé
Walnut, oiled

93 Wildeiche natur, gebürstet, geölt
Chêne nouveau naturel, brossé, huilé
Wildoak natural, brushed, oiled

selezione

01

MODELLAUSWAHL

Sélection du modèle | Model selection

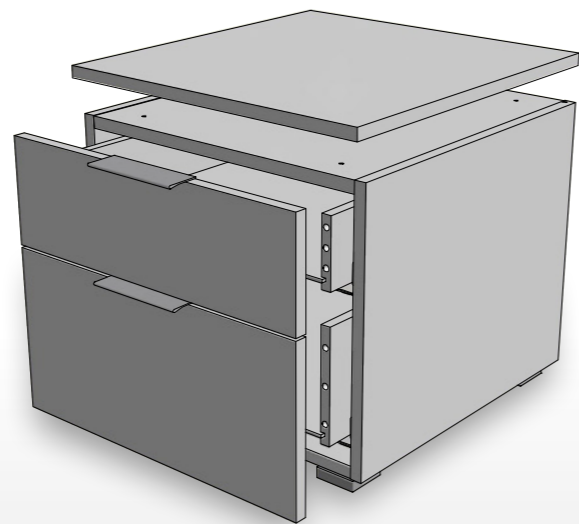

02

KORPUS

Caisson | Body



03

TOP/FRONT

Farben | Couleurs | Colours



04

GRIFFE

Poignées | Handles

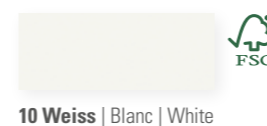
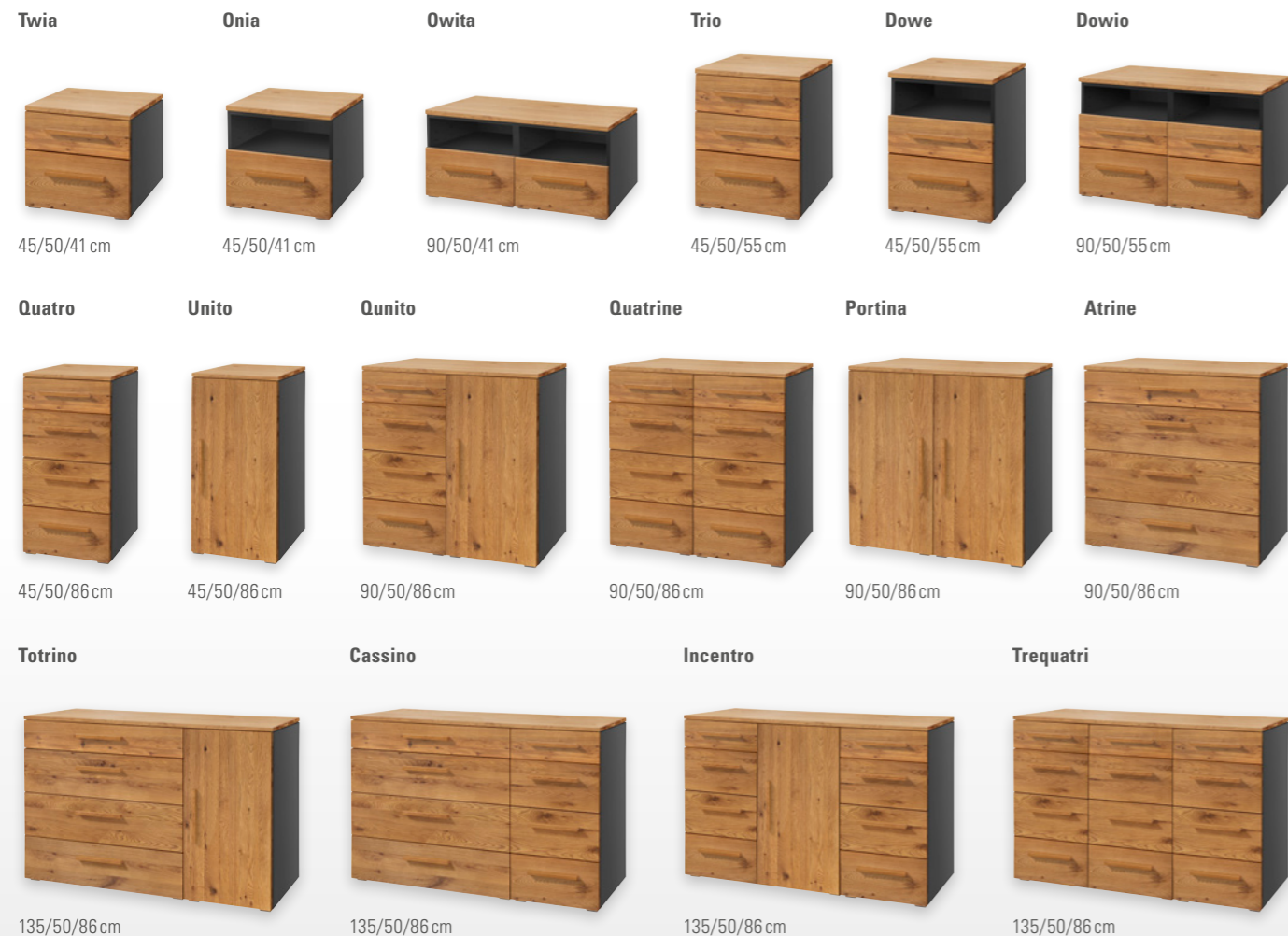

10 Weiss | Blanc | White

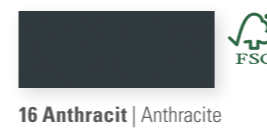

16 Anthracit | Anthracite

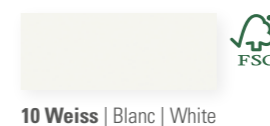

10 Weiss | Blanc | White

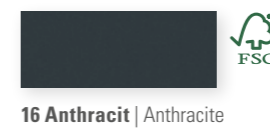

16 Anthracit | Anthracite



Pieds | Feet

STANDARD



OPTION

Leg 8 cm



Alu

Jone 10 cm



Anthracit
Used

Cila 10 cm



Anthracit

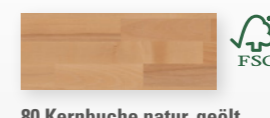

80 Kernbuche natur, geölt
Hêtre cœur rouge
naturel, huilé
Heart beech natural, oiled

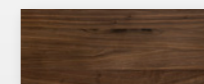

82 Nussbaum, geölt
Noyer, huilé
Walnut, oiled

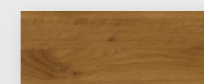

99 Wildeiche natur, geölt
Chêne nouveau naturel, huilé
Wildoak natural, oiled

STANDARD



Alu

Griff zu Folienfronten

Poignée pour façades en mélaminé
Handle for foil fronts

STANDARD



Holzgriff zu Holzfronten

Poignée en bois pour façades en bois
Wooden handle for wooden fronts

OPTION

Rivo



Used



Anthracit

Metallgriff zu Holzfronten

Poignée en métal pour façades en bois
Metal handle for wooden fronts

Stellen Sie sich Ihr Wunsch-Beimöbel nach Ihrem Geschmack zusammen: Der Korpus (Abb. 02), in zwei verschiedenen Farbvarianten, lässt sich zu den Front- und Top-Covern (Abb. 03) in acht Holz- und Farbausführungen kombinieren. Die Beimöbel können zerlegt oder teilmontiert bestellt werden. Bei zusammengesetzten Möbeln (z. B. Qunito, Incentro, ...) muss der Deckel noch montiert werden. Bei Kommoden mit Türen ist jeweils ein Einlegeboden vorhanden, Türöffnung nach links oder rechts möglich. Zusätzliche Böden sind erhältlich.

Composez le meuble d'appoint de vos rêves selon vos goûts : Le caisson (ill. 02), disponible en 2 variantes de couleurs, peut être combiné avec les façades et couvercles supérieurs (ill. 03) en 8 finitions de bois et de coloris. Les meubles d'appoint peuvent être commandés en kits ou assemblés. Pour les meubles assemblés (p. ex. Qunito, Incentro, ...) le couvercle doit encore être fixé. Les commodes avec portes sont équipées d'une étagère, ouverture de la porte possible à gauche ou à droite. Si besoin, des étagères supplémentaires sont disponibles.

Put together the side furniture you want according to your own taste: The body (fig. 02), in two different colour versions, can be combined with the front and top covers (fig. 03) in eight wood and colour versions. The furniture can be ordered disassembled or assembled. For assembled furniture (e.g. Qunito, Incentro, ...) the top cover must still be fitted. Chests of drawers with doors have one shelf, door opening possible to the left or right. Additional shelves are available.



Kombinationsbeispiele
und techn. Informationen
Exemples et informations
Examples and informations





				Dimension cm
Twia	Nachttisch	Table de nuit	Bedside table	45/50/41
Quatro	Kommode	Commode	Chest of drawer	45/50/86



Alle Holzteile in Wildeiche natur, geölt oder anthracit
 Toutes les parties en chêne naturel, huilé ou anthracite
 All wooden parts in wildoak natural, oiled or anthracite

				Dimension cm
Bergamo 4S	Rahmen Breiten Längen	Cadre Largeurs Longueurs	Frame Widths Lengths	90, 100, 120, 140, 160, 180, 200 200, 210
Lana	Füße Höhen	Pieds Hauteurs	Feet Heights	20, 25
Amy	Kopfteil Cyclo cream 730	Tête de lit Cyclo cream 730	Headboard Cyclo cream 730	140, 160, 180, 200

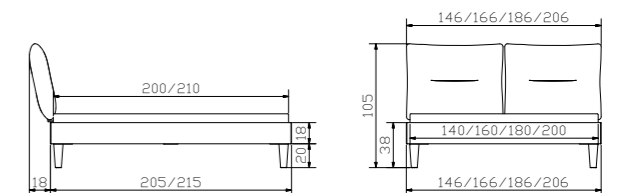



				Dimension cm
Bergamo 4S	Rahmen Breiten Längen	Cadre Largeurs Longueurs	Frame Widths Lengths	90, 100, 120, 140, 160, 180, 200 200, 210
Glyd anthracit	Kufen Breiten Höhen	Patins Largeurs Hauteurs	Skids Widths Heights	140, 160, 180, 200 20, 25
Turano	Kopfteil	Tête de lit	Headboard	140, 160, 180/200
Jose anthracit	Nachttisch	Table de nuit	Bedside table	50/41/36

Alle Holzteile in Nussbaum, geölt
Toutes les parties en noyer, huilé
All wooden parts in walnut, oiled

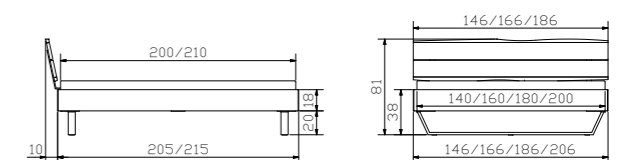



				Dimension cm
Jaca	Nachttisch	Table de nuit	Bedside table	50/41/42
Claudio alu	Herrendiener	Valet	Dressboy	45/28/107

				Dimension cm
Bergamo 4S	Rahmen Breiten Längen	Cadre Largeurs Longueurs	Frame Widths Lengths	90, 100, 120, 140, 160, 180, 200 200, 210
Nelo	Füße Höhen	Pieds Hauteurs	Feet Heights	20, 25
Ello	Kopfteil	Tête de lit	Headboard	90/100, 120, 140, 160, 180/200

Alle Holzteile in Kernbuche natur, geölt
 Toutes les parties en hêtre cœur rouge naturel, huilé
 All wooden parts in heart beech natural, oiled

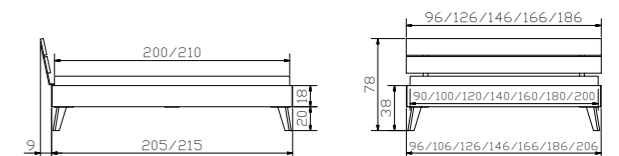



				Dimension cm
Jaca	Nachttisch	Table de nuit	Bedside table	50/41/42
Smart black	Leselampe	Lampe de lecture	Reading lamp	

				Dimension cm
Bergamo 4S	Rahmen Breiten Längen	Cadre Largeurs Longueurs	Frame Widths Lengths	90, 100, 120, 140, 160, 180, 200 200, 210
Nelo	Füße Höhen	Pieds Hauteurs	Feet Heights	20, 25
Montello	Kopfteil	Tête de lit	Headboard	90/100, 120, 140, 160, 180/200

Alle Holzteile in Wildeiche natur, geölt
 Toutes les parties en chêne naturel, huilé
 All wooden parts in wildoak natural, oiled

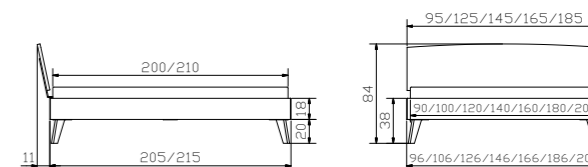



				Dimension cm
Salva	Nachttisch	Table de nuit	Bedside table	48/40/35

				Dimension cm
Bergamo 4S	Rahmen Breiten Längen	Cadre Largeurs Longueurs	Frame Widths Lengths	90, 100, 120, 140, 160, 180, 200 200, 210
Tunca	Füße Höhen	Pieds Hauteurs	Feet Heights	20, 25
Pella Lola	Kopfteil Kissen Pepe grey 335	Tête de lit Coussin Pepe grey 335	Headboard Cushion Pepe grey 335	90/100, 120, 140, 160, 180/200 140, 160, 180/200

Alle Holzteile in Kernbuche natur, geölt
 Toutes les parties en hêtre coeur rouge naturel, huilé
 All wooden parts in heart beech natural, oiled

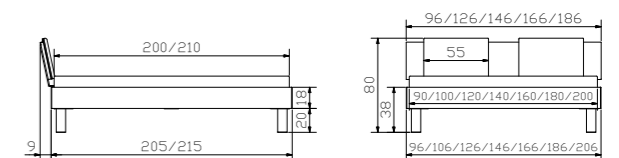



				Dimension cm
Jose anthracit	Nachttisch	Table de nuit	Bedside table	50/41/36

				Dimension cm
Bergamo 4S	Rahmen Breiten Längen	Cadre Largeurs Longueurs	Frame Widths Lengths	90, 100, 120, 140, 160, 180, 200 200, 210
Glyd anthracit	Kufen Breiten Höhen	Patins Largeurs Hauteurs	Skids Widths Heights	140, 160, 180, 200 20, 25
Amy	Kopfteil Fusio anthracit 751	Tête de lit Fusio anthracit 751	Headboard Fusio anthracit 751	140, 160, 180, 200

Alle Holzteile in Nussbaum, geölt
 Toutes les parties en noyer, huilé
 All wooden parts in walnut, oiled

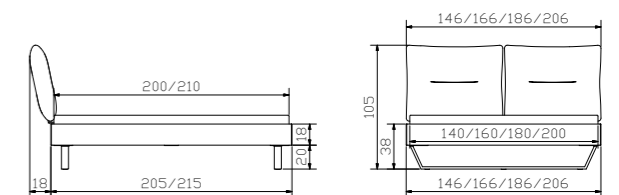



Dimension cm

Bergamo 4S	Rahmen Breiten Länge	Cadre Largeurs Longueur	Frame Widths Length	90, 100, 120, 140, 160, 180, 200 200, 210
Roca iron	Füße Höhen	Pieds Hauteurs	Feets Heights	20, 25
Salva	Nachttisch	Table de nuit	Bedside table	48/40/35

Alle Holzteile in Wildeiche natur, geölt
Toutes les parties en chêne naturel, huilé
All wooden parts in wildoak natural, oiled

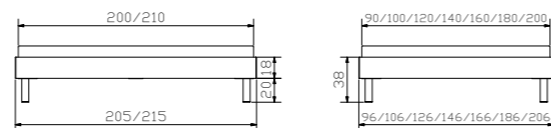

Dimension cm

Bergamo 4S	Rahmen Breiten Längen	Cadre Largeurs Longueurs	Frame Widths Lengths	90, 100, 120, 140, 160, 180, 200 200, 210
Nelo	Füße Höhen	Pieds Hauteurs	Feets Heights	20, 25
Salva	Nachttisch	Table de nuit	Bedside table	48/40/35

Alle Holzteile in Wildeiche natur, geölt
Toutes les parties en chêne naturel, huilé
All wooden parts in wildoak natural, oiled

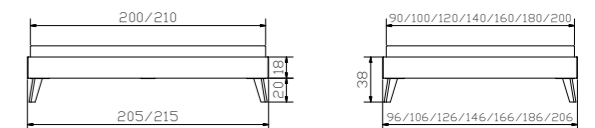



				Dimension cm
Akai	Nachttisch	Table de nuit	Bedside table	50/41/16

				Dimension cm
Bergamo 3S	Rahmen Breiten Längen	Cadre Largeurs Longueurs	Frame Widths Lengths	140, 160, 180, 200 200, 210
Nelo	Füße Höhen	Pieds Hauteurs	Feets Heights	20, 25
Sofia	Kopfteil Buffalo grey 721	Tête de lit Buffalo grey 721	Headboard Buffalo grey 721	140, 160, 180

Alle Holzteile in Wildeiche natur, geölt
 Toutes les parties en chêne naturel, huilé
 All wooden parts in wildoak natural, oiled

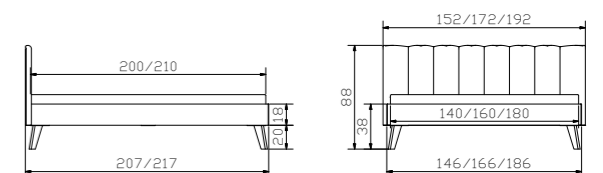



				Dimension cm
Jose anthracit	Nachttisch	Table de nuit	Bedside table	50/41/36

				Dimension cm
Bergamo 3S	Rahmen Breiten Längen	Cadre Largeurs Longueurs	Frame Widths Lengths	140, 160, 180, 200 200, 210
Glyd anthracit	Kufen Breiten Höhen	Patins Largeurs Hauteurs	Skids Widths Heights	140, 160, 180, 200 20, 25
Samira	Kopfteil Alpina lightgrey 390	Tête de lit Alpina lightgrey 390	Headboard Alpina lightgrey 390	140, 160, 180, 200

Alle Holzteile in Wildeiche natur, geölt
 Toutes les parties en chêne noueux naturel, huilé
 All wooden parts in wildoak natural, oiled

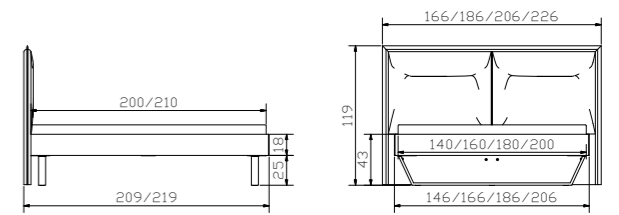



				Dimension cm
Dowe	Nachttisch	Table de nuit	Bedside table	45/50/55
Totino	Kommode	Commode	Chest of drawer	135/50/86

				Dimension cm
Bergamo 3S	Rahmen Breiten Längen	Cadre Largeurs Longueurs	Frame Widths Lengths	140, 160, 180, 200 200, 210
Lana	Füße Höhen	Pieds Hauteurs	Feets Heights	20, 25
Cloe	Kopfteil Ritorno anthracit 641	Tête de lit Ritorno anthracit 641	Headboard Ritorno anthracit 641	140, 160, 180, 200

Alle Holzteile in Nussbaum, geölt oder anthracit
 Toutes les parties en noyer, huilé ou anthracite
 All wooden parts in walnut, oiled or anthracite

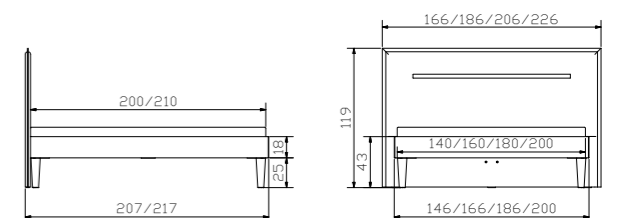



				Dimension cm
Jaca	Nachttisch	Table de nuit	Bedside table	50/41/42

				Dimension cm
Bergamo 3S	Rahmen Breiten Längen	Cadre Largeurs Longueurs	Frame Widths Lengths	140, 160, 180, 200 200, 210
Delo	Füße, 2er Set Höhen	Pieds, set de 2 pièces Hauteurs	Feets, set of 2 Heights	20, 25
Samira	Kopfteil Campos creme 373	Tête de lit Campos creme 373	Headboard Campos creme 373	140, 160, 180, 200

Alle Holzteile in Wildeiche natur, geölt
 Toutes les parties en chêne naturel, huilé
 All wooden parts in wildoak natural, oiled

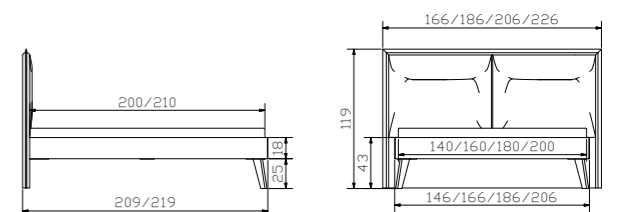



				Dimension cm
Akai	Nachttisch	Table de nuit	Bedside table	50/41/16
Roll-Box 25	Bettkasten Höhen	Tiroir de lit Hauteurs	Bed drawer Heights	137/67 20, 25

				Dimension cm
Bergamo 3S	Rahmen Breiten Längen	Cadre Largeurs Longueurs	Frame Widths Lengths	140, 160, 180, 200 200, 210
Tunca	Füße Höhen	Pieds Hauteurs	Feet Heights	20, 25
Cloe	Kopfteil Alpina lightgrey 390	Tête de lit Alpina lightgrey 390	Headboard Alpina lightgrey 390	140, 160, 180, 200

Alle Holzteile in Kernbuche natur, geölt
 Toutes les parties en hêtre cœur rouge naturel, huilé
 All wooden parts in heart beech natural, oiled

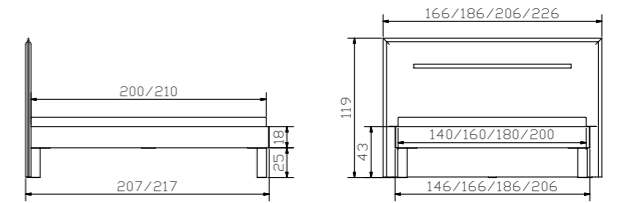



				Dimension cm
Trio	Nachttisch	Table de nuit	Bedside table	45/50/55
Qunito	Kommode	Commode	Chest of drawer	90/50/86

				Dimension cm
Bergamo 3S	Rahmen Breiten Längen	Cadre Largeurs Longueurs	Frame Widths Lengths	140, 160, 180, 200 200, 210
Lana	Füsse Höhen	Pieds Hauteurs	Feet Heights	20, 25
Jaro	Kopfteil Kul white 323	Tête de lit Kul white 323	Headboard Kul white 323	140, 160, 180

Alle Holzteile in Kernbuche natur, geölt oder anthracit
 Toutes les parties en hêtre cœur rouge naturel, huilé ou anthracite
 All wooden parts in heart beech natural, oiled or anthracite

