



swiss bed concept



# LOUNGE

MASSIVHOLZ | BOIS MASSIF | SOLID WOOD

Achten Sie auf FSC®-zertifizierte Produkte | Soyez attentifs aux produits certifiés FSC® | Look for FSC®-certified products

# Hasena – mein Bett

Hasena – mon lit | Hasena – my bed

## Beständige Passion

Une passion constante  
Enduring Passion

### Mehr als ein Lebenswerk

Seit 1951 überzeugen wir mit hoher Qualität und Vielseitigkeit im Bereich Schlafzimmermöbel.

### Plus que l'œuvre d'une vie

Depuis 1951, nous convainquons par notre qualité élevée et notre polyvalence dans le domaine des meubles de chambre à coucher.

### More than a life's work

Since 1951 we have been convincing with high quality and versatility in the bedroom furniture sector.



## swiss bed concept



swiss bed concept

### Ein cleveres Baukastensystem

Sie wählen Ihren favorisierten Bettrahmen aus und kombinieren dazu Füße und Kopfteil Ihrer Wahl. Dabei können Sie quer durch die Kollektionen auf unterschiedliche Materialien und Farben zugreifen.

### Un système modulaire astucieux

Choisissez votre cadre de lit préféré et combinez-le avec les pieds et la tête de lit de votre choix. Vous pouvez choisir parmi une variété de matériaux et de couleurs dans toutes les collections.

### A clever modular system

You choose your favourite bed frame and combine it with the feet and headboard of your choice. You can choose from a variety of materials and colours throughout the collections.

## 5 Jahre Garantie

5 ans de garantie  
5 years warranty



### Unser Versprechen

Vom Baum zum Bett – mittels handwerklicher Perfektion und hochwertigen Materialien. Sie erhalten 5 Jahre Garantie auf die Material- und Oberflächenbeschaffenheit, sowie die fachgerechte Verarbeitung aller Modelle ab Kaufdatum. Weitere Informationen finden Sie auf unserer Website.

### Notre promesse

De l'arbre au lit – grâce à un artisanat parfait et des matériaux de haute qualité. Vous bénéficiez d'une garantie de 5 ans sur la qualité des matériaux et des surfaces, ainsi que sur la fabrication professionnelle de tous les modèles à compter de la date d'achat. Vous trouverez plus d'informations sur notre site Internet.

### Our promise

From tree to bed – by means of perfect craftsmanship and high-quality materials. You receive a 5-year guarantee on the material and surface quality, as well as the professional workmanship of all models from the date of purchase. Further information can be found on our website.

## Schnellieferservice

Service de livraison rapide  
Quick delivery service



### Komfort ohne Wartezeit

Mit unserem Schnellieferservice «PRONTO» können wir eine grosse Auswahl an Betten mit Beimöbeln und alle Modelle aus Edition pronto, Dream pronto und Boxspring pronto ab Lager liefern.

### Le confort sans délai d'attente

Notre service de livraison rapide « PRONTO » permet de livrer un large choix de lits, de meubles d'appoint et tous les modèles de l'Édition Pronto, Dream pronto et Boxspring Pronto à partir du stock.

### Comfort without waiting

With our „PRONTO“ fast delivery service, we can deliver a large selection of beds with ancillary furniture and all models from Edition pronto, Dream pronto and Boxspring pronto from stock.



### Mehr über Hasena

En savoir plus sur Hasena  
More about Hasena



## Vielseitig kombinierbar

Unser ausgeklügeltes Baukastensystem «swiss bed concept» bietet eine riesige Auswahl an Füßen, Kopfteilen und Beimöbeln. Darüber hinaus umfasst es verschiedene Stoff-, Kunstleder- und Lederbezüge sowie diverse Holz- und Metallausführungen. Abgestimmte Lattenroste und Matratzen komplettieren unsere Betten zur Wohlfühloase.

## Combinable à souhait

Notre système modulaire sophistiqué «swiss bed concept» propose un large choix de pieds, têtes de lits et accessoires. Par ailleurs il comporte différents tissus, cuirs synthétiques et véritables, ainsi que diverses variantes de bois et métal. Des sommiers à lattes et des matelas adaptés complètent nos lits pour un espace bien-être.

## Versatile combinable

Our ingenious modular system «swiss bed concept» offers a huge selection of feet, headboards and accessories. In addition, it includes different fabrics, synthetic leather and real leather covers and different wood and metal versions. Matching slatted frames and mattresses complete our beds to an oasis of well-being.



## Stabil im Aufbau

Unsere Betten überzeugen durch eine hohe Stabilität. Mittels Einsatz verschiedener Traversen ist eine gesamthafte Belastung von 300 bis 450 kg, inklusive Lattenroste und Matratzen, möglich.

## Construction robuste

Nos lits sont convainquants par leur grande stabilité. En utilisant différentes traverses, une charge totale de 300 à 450 kg, y compris sommiers et matelas, est possible.

## Solid in construction

Our beds convince with their high stability. By using different trusses, a total load of 300 to 450 kg, including slatted frames and mattresses, is possible.



## Einfach in der Montage

Unser Betten-System begeistert durch einen einfachen Aufbau mit leicht verständlicher Montageanleitung sowie hochwertigen Verbindungselementen, welche einen vielfachen Ab- und Wiederaufbau ermöglichen.

## Montage facile

Notre système de lits séduit par un montage facile grâce aux instructions aisément compréhensibles ainsi que par les éléments de fixation haut de gamme permettant de monter et démonter les lits à de nombreuses reprises.

## Easy to install

Our bed system impresses with its simple, easy-to-understand assembly instructions and high-quality connecting elements, which enable multiple dismantling and reassembly.

## Nachhaltigkeit bei Hasena

Unser wichtigster Lieferant, die Natur, ist sensibel und benötigt lange Regenerationszeiten bei Überbeanspruchung. Wir respektieren die von uns genutzten Ökosysteme und stellen unsere Produkte nachhaltig und mit hohem sozialen Engagement her.

## Durabilité chez Hasena

Notre fournisseur le plus important, la nature, est sensible et nécessite un long temps de régénération en cas de surutilisation. Nous respectons les écosystèmes que nous utilisons et fabriquons nos produits de manière durable et avec un haut niveau d'engagement social.

## Sustainability at Hasena

Our most important supplier, nature, is sensitive and needs long regeneration times in case of overuse. We respect the ecosystems we use and manufacture our products sustainably and with a high level of social commitment.



## Soziale Verantwortung

Responsabilité sociale  
Social responsibility



## Holzbeschaffung

Approvisionnement en bois  
Wood procurement



## Produktion Massivholz

Production bois massif  
Manufacturing solid wood



## Holzoberflächen

Surfaces en bois  
Wood surfaces



## Recycelte Stoffe

Tissus recyclés  
Recycled fabrics



## Energiegewinnung

Production énergétique  
Production of energy



# Bettrahmen | Cadre de lit | Bedframe



Lounge 18

**Breiten** | Largeurs | Widths  
140, 160, 180, 200 cm

**Längen** | Longueurs | Lengths  
200, 210, 220 cm

**Einlegetiefe** | Hauteur encastrable | Insertion depth:  
18 cm



## Traversen | Traverses | Bars

**Wir empfehlen grundsätzlich den Einsatz von Crosstraver (Quertraverse) oder Midtraver (Längstraverse).**

Nous recommandons en général l'utilisation de Crosstraver (traverse transversale) ou Midtraver (traverse centrale).

We recommend basically the insertion of Crosstraver (central cross bar) or Midtraver (central bar).

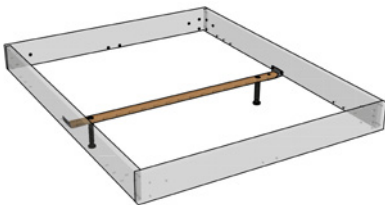

### Crosstraver

Quertraverse | Traverse transversale | Central cross bar

**Für alle Bettbreiten** | Pour toutes les largeurs de lit | For all bed widths

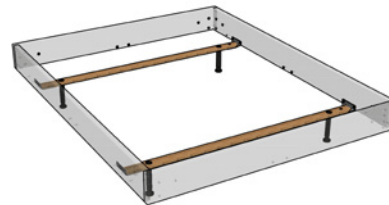

### Crosstraver-Twin

Quertraversen | Traverses transversales | Cross bars

**Für alle Bettbreiten** | Pour toutes les largeurs de lit | For all bed widths

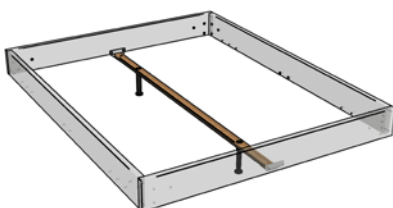

### Midtraver

Längstraverse | Traverse centrale | Central bar

**Für Betten ab Breite 140 cm mit 2 Lattenrosten oder Motorrahmen-einbau** | Pour les lits à partir de 140 cm de largeur avec 2 sommiers ou l'installation d'un cadre motorisé | For beds from 140 cm width with 2 slats or motor frame installation

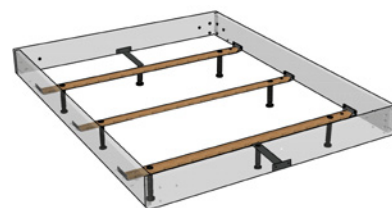

### Crosstraver-XXL

Quertraversen | Traverses transversales | Cross bars

**Für alle Bettbreiten** | Pour toutes les largeurs de lit | For all bed widths

**Übersicht Kompatibilität Traversen siehe Gesamtkatalog Seite 2.12** | Aperçu compatibilité traverses voir catalogue général page 2.12 | Overview compatibility bars see general catalogue page 2.12

# Füsse | Pieds | Feet



## Holz | Bois | Wood

	Höhen cm Hauteurs cm Heights cm		Holzfarben Couleurs bois Colours wood					
	20	25	10	16	74	82	87	99
	●	●	●	●	●	●	●	●
Pile	●	●	●	●	●	●	●	●
Practico-Rono*		●	●	●				
Masino	●	●	●	●	●	●	●	●

## Metall | Métal | Metal

	Höhen cm Hauteurs cm Heights cm		Metallfarben Couleurs métal Colours metal	
	20	25	16	42
	●	●	●	●
Tondino	●	●	●	●
Locito	●	●	●	●
Glyn	●	●	●	●

\* Practico-Rono weiss/anthrazit aus Spanplatte mit Folie belegt. Holzfüsse sind aus Massivholz | Practico-Rono blanc/anthracite en panneau aggloméré laminé. Pieds en bois massif | Practico-Rono white/anthracite made of particle board covered with foil. Wooden feet are of solid wood.

## Holz | Bois | Wood

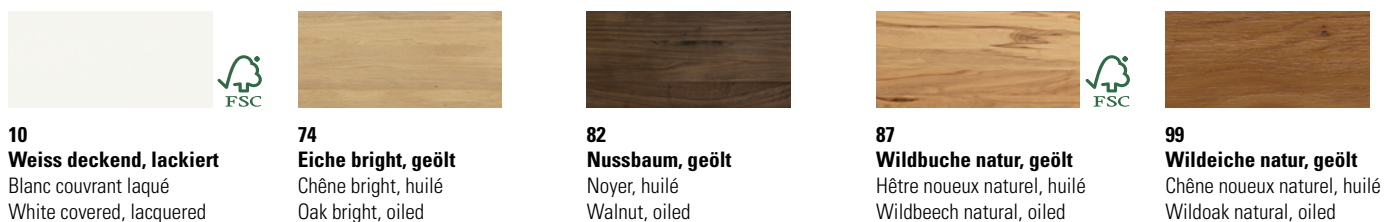

**Deklaration der Holzherkunft siehe Gesamtkatalog Einleitungsseiten**  
 Déclaration de l'origine du bois voir catalogue général pages d'introduction  
 Declaration of wood origin see general catalogue introductory pages

## Metall | Métal | Metal



# Kopfteile | Têtes de lit | Headboards

## Wave



Dimension: 140, 160, 180, 200

## Turano\*



Dimension: 140, 160, 180/200

## Kulm



Dimension: 140, 160, 180, 200

## Lola + Kulm

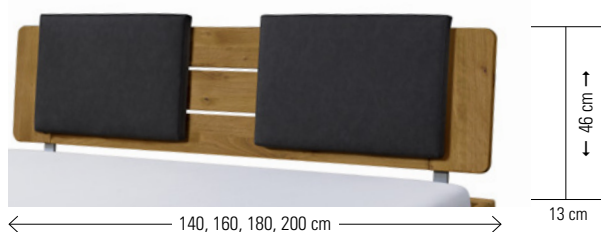

Dimension: 140, 160, 180, 200

## Comfy

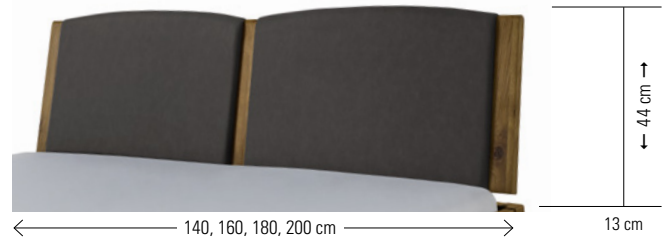

Dimension: 140, 160, 180, 200

## Lecco

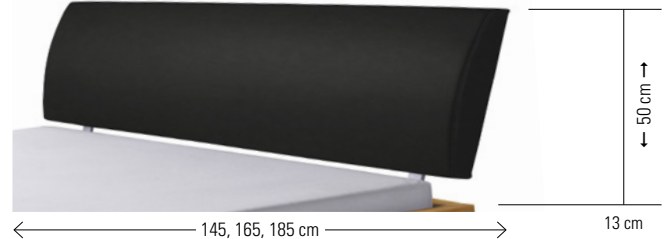

Dimension: 140, 160, 180/200

## Boga\*\*



Dimension: 140, 160, 180, 200

## Stoff- und Kunstlederauswahl

Choix de tissus  
Choice of tissues

Pepe (100 % Polyester)



323 white

Kul (Oberfläche | Surface 100% Polyurethan)



335 grey



336 smoke

## Adapter | Adaptateur | Adapter

Bei hohen Matratzen kann mit dem Verlängerungsadapter das Kopfteil erhöht werden.

La tête de lit peut être rehaussée avec l'adaptateur lorsque le matelas est plus épais.  
With the extension adapter the headboard can be extended if mattresses are high.

Head-Plus (2er Set | set de 2 | set of 2)

Head-Plus für Comfy | pour Comfy | for Comfy (3er Set | set de 3 | set of 3)

Metall | Métal | Metal

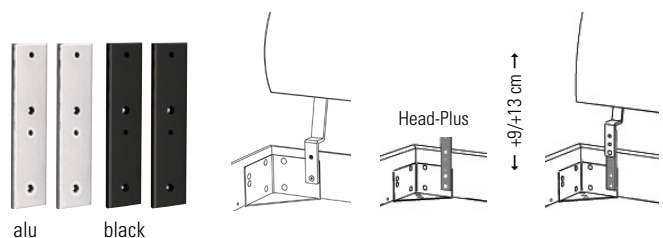

\* **Turano ausschliesslich in Nussbaum 82, Wildbuche natur 87 und Wildeiche natur 99** | Turano exclusivement en noyer 82, hêtre naturel 87 et chêne naturel 99 | Turano exclusively in walnut 82, wildbeech natural and wildoak natural 99

\*\* **Boga 200 cm nicht in den Stoffen 323/335/336 erhältlich. Nur in PK 3, siehe Register 1** | Boga 200 cm non disponible dans les tissus 323/335/336. Uniquement en CP 3, voir registre 1 | Boga 200 cm not available in fabrics 323/335/336. Only in PC 3, see index 1

# Nachttische | Tables de nuit | Bedside tables



## Ausführungen für Kopfteile und Nachttische | Exécutions pour tables de nuit et têtes de lit | Executions for bedside tables and headboards

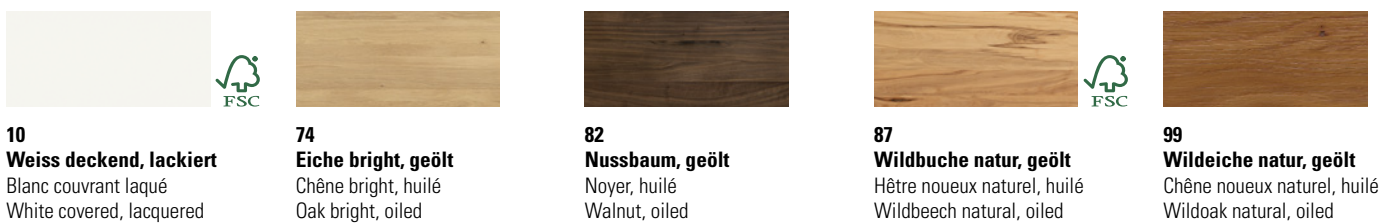

# Bettkasten | Coffres à literie | Bedding boxes



<p>Bettkasten in weiss oder anthrazit</p> <p><b>Voraussetzung</b> Bettfusshöhe von mindestens 20 cm erforderlich</p> <p><b>Optionen</b> Deckel Covero in weiss, Stoffabdeckung Saceto in Polyester grau.</p>	<p>Tiroir de lit en blanc ou anthracite</p> <p><b>Condition préalable</b> Une hauteur de pieds de lit d'au moins 20 cm.</p> <p><b>Options</b> Couvercle Covero en blanc, tissu de protection Saceto en polyester gris.</p>	<p>Bed drawer in white or anthracite</p> <p><b>Condition</b> Feet of bed need a minimum height of 20 cm.</p> <p><b>Options</b> Covero in white, tissue of protection Saceto in polyester grey.</p>
--	--	--

## Ausführungen für Bettkasten-Front | Exécutions pour façades coffres à literie | Executions for fronts of bedding boxes



# selezione

## 01

### MODELLAUSWAHL

Sélection du modèle | Model selection

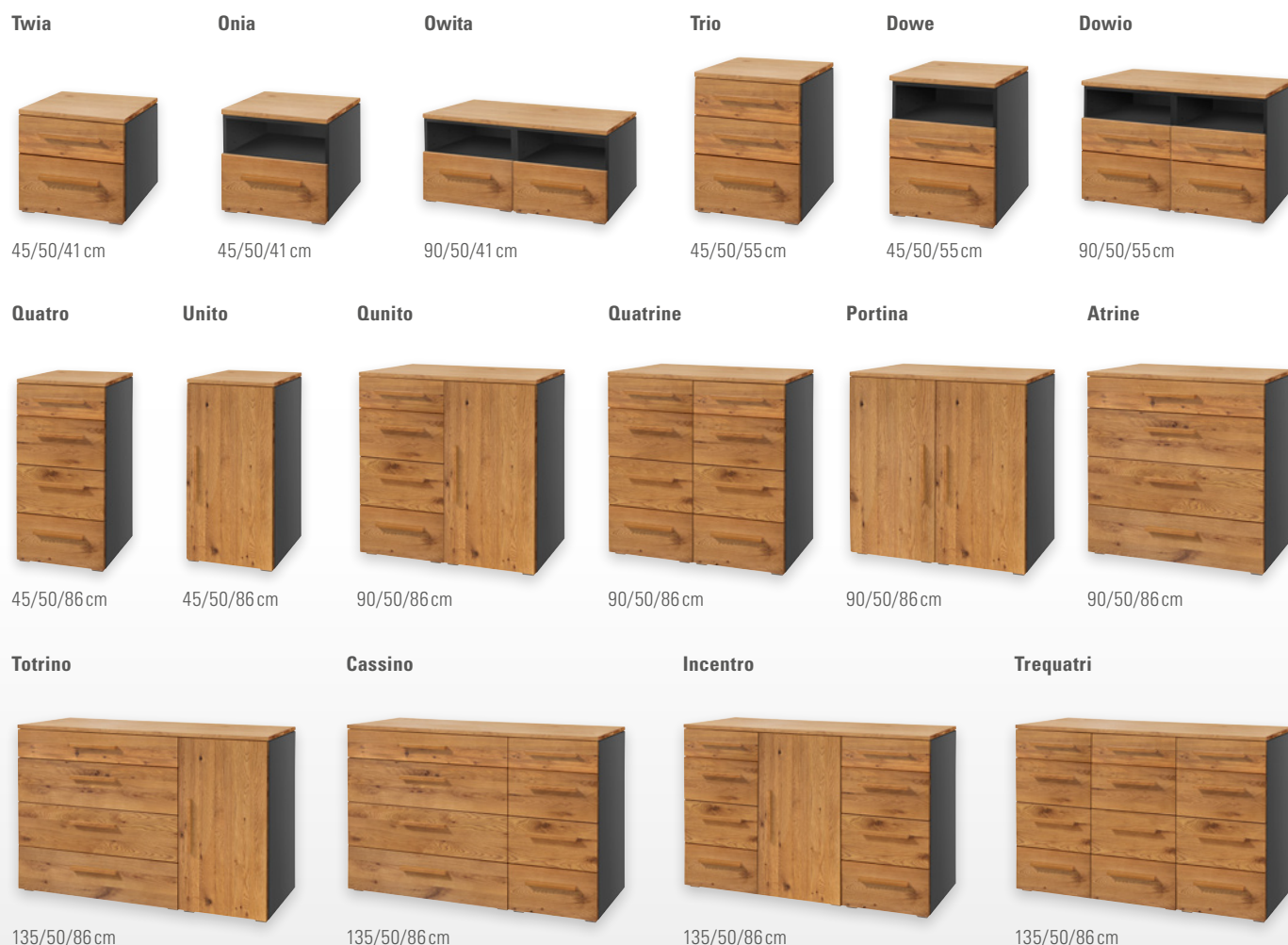
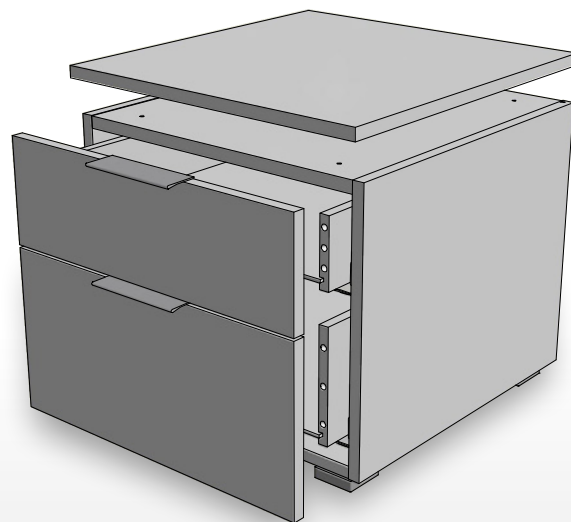

Stellen Sie sich Ihr Wunsch-Beimöbel nach Ihrem Geschmack zusammen: Der Korpus (Abb. 02), in zwei verschiedenen Farbvarianten, lässt sich zu den Front- und Top-Covern (Abb. 03) in acht Holz- und Farbausführungen kombinieren. Die Beimöbel können zerlegt oder teilmontiert bestellt werden. Bei zusammengesetzten Möbeln (z. B. Qunito, Incentro, ...) muss der Deckel noch montiert werden. Bei Kommoden mit Türen ist jeweils ein Einlegeboden vorhanden, Türöffnung nach links oder rechts möglich. Zusätzliche Böden sind erhältlich.

Composez le meuble d'appoint de vos rêves selon vos goûts : Le caisson (ill. 02), disponible en 2 variantes de couleurs, peut être combiné avec les façades et couvercles supérieurs (ill. 03) en 8 finitions de bois et de coloris. Les meubles d'appoint peuvent être commandés en kits ou assemblés. Pour les meubles assemblés (p. ex. Qunito, Incentro, ...) le couvercle doit encore être fixé. Les commodes avec portes sont équipées d'une étagère, ouverture de la porte possible à gauche ou à droite. Si besoin, des étagères supplémentaires sont disponibles.

Put together the side furniture you want according to your own taste: The body (fig. 02), in two different colour versions, can be combined with the front and top covers (fig. 03) in eight wood and colour versions. The furniture can be ordered disassembled or assembled. For assembled furniture (e.g. Qunito, Incentro, ...) the top cover must still be fitted. Chests of drawers with doors have one shelf, door opening possible to the left or right. Additional shelves are available.



**Kombinationsbeispiele und techn. Informationen**  
Exemples et informations  
Examples and informations



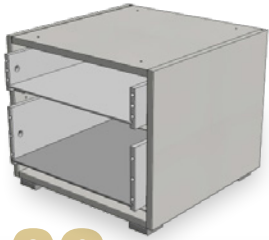

# 02

## KORPUS

Caisson | Body



# 03

## TOP/FRONT

Farben | Couleurs | Colours

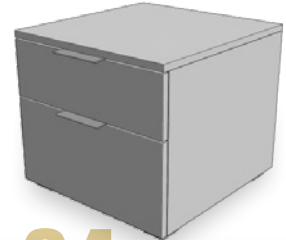

# 04

## GRIFFE

Poignées | Handles



10 Weiss | Blanc | White



16 Anthracit | Anthracite



## FÜSSE

Pieds | Feet

### STANDARD



### OPTION

Leg 8 cm

Jone 10 cm

Cila 10 cm



Alu



Anthracit  
Used



Anthracit



10 Weiss | Blanc | White



16 Anthracit | Anthracite

### STANDARD



Alu

#### Griff zu Folienfronten

Poignée pour façades en mélaminé  
Handle for foil fronts

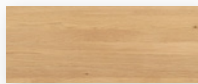

74 Eiche bright, geölt  
Chêne bright, huilé  
Oak bright, oiled

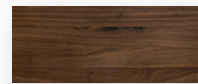

82 Nussbaum, geölt  
Noyer, huilé  
Walnut, oiled

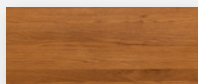

76 Eiche brandy, geölt  
Chêne brandy, huilé  
Oak brandy, oiled

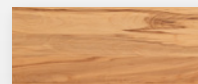

87 Wildbuche natur, geölt  
Hêtre nouveau naturel, huilé  
Wildbeech natural, oiled

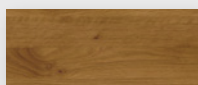

99 Wildeiche natur, geölt  
Chêne nouveau naturel, huilé  
Wildoak natural, oiled



80 Kernbuche natur, geölt  
Hêtre coeur rouge naturel, huilé  
Heart beech natural, oiled

### STANDARD



#### Holzgriff zu Holzfronten

Poignée en bois pour façades en bois  
Wooden handle for wooden fronts

### OPTION

Rivo



Used



Anthracit

#### Metallgriff zu Holzfronten

Poignée en métal pour façades en bois  
Metal handle for wooden fronts



The mark of  
responsible forestry  
FSC® C123546

Look for FSC® certified products



Surf anthracit

Nachttisch

Table de nuit

Bedside table

Dimension cm

48/38/36



**Alle Holzteile in Nussbaum, geölt** | Toutes les parties en bois en noyer, huilé | All wooden parts in walnut, oiled

**Weitere Beimöbel siehe Gesamtkatalog Register 2** | Autres accessoires voir catalogue général registre 2 | Further accessories see general catalogue index 2



**Lounge 18**

Rahmen  
Breiten  
Längen

Cadre  
Largeurs  
Longueurs

Frame  
Widths  
Lengths

**Dimension cm**

140, 160, 180, 200  
200, 210, 220

**Glyn anthracit**

Kufen  
Breiten  
Höhen

Patins  
Largeurs  
Hauteurs

Vats  
Widths  
Heights

140, 160, 180, 200  
20, 25

**Wave**

Kopfteil

Tête de lit

Headboard

140, 160, 180, 200

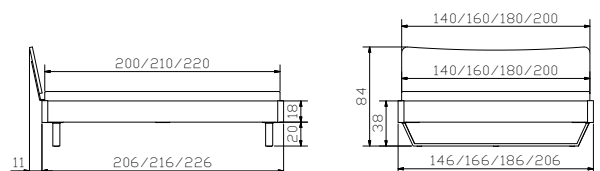

1



2



3



4



- 1. Holzteile in Wildeiche natur, geölt** | Parties en bois en chêne nouveaux naturel, huilé | All wooden parts in wildoak natural, oiled
- 2. Holzteile in Buche weiss, deckend, lackiert** | Parties en bois en hêtre teinté blanc couvrant, laqué | All wooden parts in beech white covered, lacquered
- 3. Holzteile in Nussbaum, geölt** | Parties en bois en noyer, huilé | All wooden parts in walnut, oiled
- 4. Holzteile in Eiche bright, geölt** | Parties en bois en chêne bright, huilé | All wooden parts in oak bright, oiled





				Dimension cm
<b>Lounge 18</b>	Rahmen Breiten Längen	Cadre Largeurs Longueurs	Frame Widths lengths	140, 160, 180, 200 200, 210, 220
<b>Pile</b>	Füsse Höhen	Pieds Hauteurs	Feet Heights	20, 25
<b>Kulm</b>	Kopfteil	Tête de lit	Headboard	140, 160, 180, 200
<b>Seva</b>	Nachttisch	Table de nuit	Bedside table	48/38/16



**Alle Holzteile in Wildbuche natur, geölt**

Toutes les parties en bois en hêtre nouveau naturel, huilé  
All wooden parts in wildbeech natural, oiled

**Weitere Beimöbel siehe Gesamtkatalog Register 2**

Autres accessoires voir catalogue général registre 2  
Further accessories see general catalogue index 2

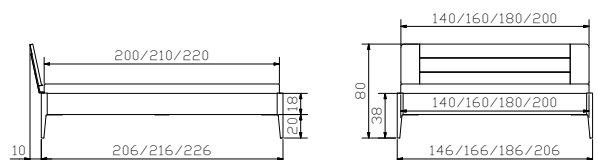



<b>Drift</b>	Nachttisch	Table de nuit	Bedside table	<b>Dimension cm</b> 48/38/9
--------------	------------	---------------	---------------	--------------------------------



**Alle Holzteile in Buche weiss, deckend, lackiert** | Toutes les parties en bois en hêtre teinté blanc couvrant, laqué | All wooden parts in beech white covered, lacquered

**Weitere Beimöbel siehe Gesamtkatalog Register 2** | Autres accessoires voir catalogue général registre 2 | Further accessories see general catalogue index 2



<b>Dimension cm</b>				
<b>Lounge 18</b>	Rahmen Breiten Längen	Cadre Largeurs Longueurs	Frame Widths Lengths	140, 160, 180, 200 200, 210, 220
<b>Pile</b>	Füsse Höhen	Pieds Hauteurs	Feet Heights	20, 25
<b>Lecco</b>	Kopfteil Pepe grey 335	Tête de lit Pepe grey 335	Headboard Pepe grey 335	140, 160, 180/200

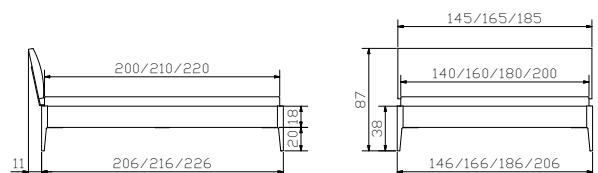



Styly

Nachttisch

Table de nuit

Bedside table

**Dimension cm**

43/43/48



**Alle Holzteile in Eiche bright, geölt** | Toutes les parties en bois en chêne bright, huilé | All wooden parts in oak bright, oiled

**Weitere Beimöbel siehe Gesamtkatalog Register 2** | Autres accessoires voir catalogue général registre 2 | Further accessories see general catalogue index 2





	<b>Dimension cm</b>			
<b>Lounge 18</b>	Rahmen Breiten Längen	Cadre Largeurs Longueurs	Frame Widths Lengths	140, 160, 180, 200 200, 210, 220
<b>Pile</b>	Füße Höhen	Pieds Hauteurs	Feet Heights	20, 25
<b>Boga</b>	Kopfteil Pepe grey 335	Tête de lit Pepe grey 335	Headboard Pepe grey 335	140, 160, 180

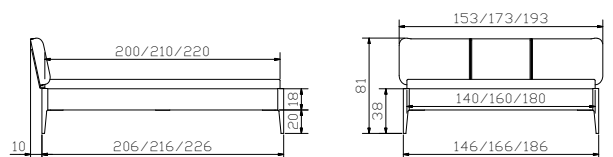



Surf anthracit

Nachttisch

Table de nuit

Bedside table

**Dimension cm**

48/38/36



**Alle Holzteile in Wildeiche natur, geölt** | Toutes les parties en bois en chêne naturel, huilé | All wooden parts in wildoak natural, oiled

**Weitere Beimöbel siehe Gesamtkatalog Register 2** | Autres accessoires voir catalogue général registre 2 | Further accessories see general catalogue index 2



				<b>Dimension cm</b>
<b>Lounge 18</b>	Rahmen Breiten Längen	Cadre Largeurs Longueurs	Frame Widths Lengths	140, 160, 180, 200 200, 210, 220
<b>Glyn anthracit</b>	Kufen Breiten Höhen	Patins Largeurs Hauteurs	Vats Widths Heights	140, 160, 180, 200 20, 25
<b>Turano</b>	Kopfteil	Tête de lit	Headboard	140, 160, 180/200

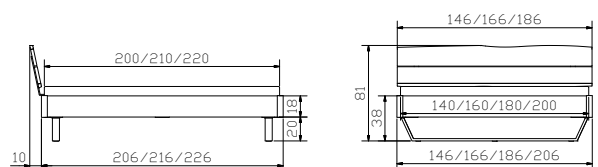

1



2



3



- 1. Holzteile in Wildeiche natur, geölt** | Parties en bois en chêne nouveau naturel, huilé | Wooden parts in wildoak natural, oiled  
**2. Holzteile in Eiche bright, geölt** | Parties en bois en chêne bright, huilé | Wooden parts in oak bright, oiled  
**3. Holzteile in Wildbuche natur, geölt** | Parties en bois en hêtre nouveau naturel, huilé | Wooden parts in wildbeech natural, oiled





				<b>Dimension cm</b>
<b>Lounge 18</b>	Rahmen Breiten Längen	Cadre Largeurs Longueurs	Frame Widths Lengths	140, 160, 180, 200 200, 210, 220
<b>Locito anthracit</b>	Füße Höhe	Pieds Hauteur	Feet Height	20
<b>Lecco</b>	Kopfteil Kul smoke 336	Tête de lit Kul smoke 336	Headboard Kul smoke 336	140, 160, 180/200
<b>Dowe</b> <b>Cila 10 anthracit</b>	Nachttisch Füße	Table de nuit Pieds	Bedside table Feet	45/50/55 10



**Alle Holzteile in Nussbaum, geölt**  
Toutes les parties en bois en noyer, huilé  
All wooden parts in walnut, oiled

**Weitere Beimöbel siehe Gesamtkatalog Register 2** | Autres accessoires voir catalogue général registre 2 | Further accessories see general catalogue index 2

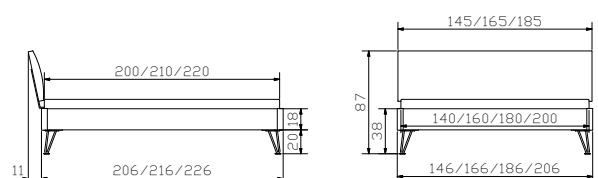



				<b>Dimension cm</b>
<b>Seva</b>	Nachttisch	Table de nuit	Bedside table	48/38/16



**Alle Holzteile in Wildbuche natur, geölt** | Toutes les parties en hêtre naturel, huilé | All wooden parts in wildbeech natural, oiled  
**Weitere Beimöbel siehe Gesamtkatalog Register 2** | Autres accessoires voir catalogue général registre 2 | Further accessories see general catalogue index 2



				Dimension cm
<b>Lounge 18</b>	Rahmen Breiten Längen	Cadre Largeurs Longueurs	Frame Widths Lengths	140, 160, 180, 200 200, 210, 220
<b>Tondino anthracit</b>	Füße Höhe	Pieds Hauteur	Feet Height	20
<b>Lecco</b>	Kopfteil Kul smoke 336	Tête de lit Kul smoke 336	Headboard Kul smoke 336	140, 160, 180/200

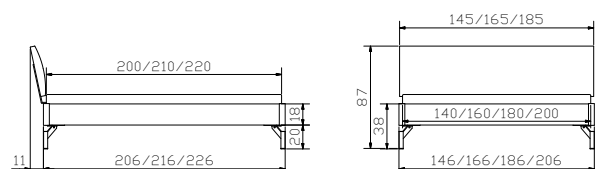



				<b>Dimension cm</b>
<b>Styl</b>	Nachttisch	Table de nuit	Bedside table	43/43/48
<b>Roll-Box</b>	Bettkasten, anthrazit Höhen	Tiroir de lit, anthracite Hauteurs	Bed drawer, anthracite Heights	137/67 19, 24



**Roll-Box 20 + 25**

**Wildeiche natur, gebürstet, geölt**  
Chêne noueux naturel, brossé, huilé  
Wildoak natural, brushed, oiled





				<b>Dimension cm</b>
<b>Lounge 18</b>	Rahmen Breiten Längen	Cadre Largeurs Longueurs	Frame Widths Lengths	140, 160, 180, 200 200, 210, 220
<b>Pile</b>	Füsse Höhen	Pieds Hauteurs	Feet Heights	20, 25
<b>Wave</b>	Kopfteil	Tête de lit	Headboard	140, 160, 180, 200



**Alle Holzteile in Wildeiche natur, geölt**

Toutes les parties en bois en chêne nouveau naturel, huilé  
All wooden parts in wildoak natural, oiled

**Weitere Beimöbel siehe Gesamtkatalog Register 2**

Autres accessoires voir catalogue général registre 2  
Further accessories see general catalogue index 2

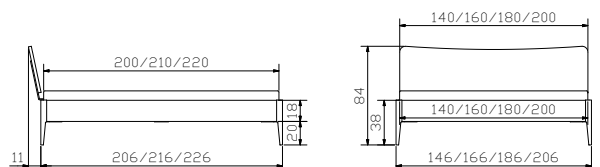



Seva

Nachttisch

Table de nuit

Bedside table

Dimension cm

48/38/16



**Alle Holzteile in Buche weiss, deckend, lackiert** | Toutes les parties en bois en hêtre teinté blanc couvrant, laqué | All wooden parts in beech white covered, lacquered

**Weitere Beimöbel siehe Gesamtkatalog Register 2** | Autres accessoires voir catalogue général registre 2 | Further accessories see general catalogue index 2



				<b>Dimension cm</b>
<b>Lounge 18</b>	Rahmen Breiten Längen	Cadre Largeurs Longueurs	Frame Widths Lengths	140, 160, 180, 200 200, 210, 220
<b>Pile</b>	Füße Höhen	Pieds Hauteurs	Feet Heights	20, 25
<b>Comfy</b>	Kopfteil Pepe grey 335	Tête de lit Pepe grey 335	Headboard Pepe grey 335	140, 160, 180, 200

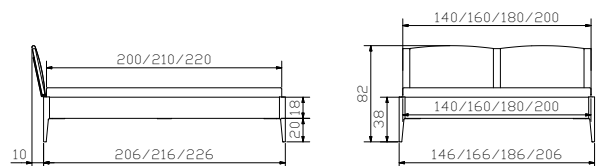



Stand

Nachttisch

Table de nuit

Bedside table

**Dimension cm**

48/38/42



**Alle Holzteile in Eiche bright, geölt** | Toutes les parties en bois en chêne bright, huilé | All wooden parts in oak bright, oiled

**Weitere Beimöbel siehe Gesamtkatalog Register 2** | Autres accessoires voir catalogue général registre 2 | Further accessories see general catalogue index 2



				<b>Dimension cm</b>
<b>Lounge 18</b>	Rahmen Breiten Längen	Cadre Largeurs Longueurs	Frame Widths Lengths	140, 160, 180, 200 200, 210, 220
<b>Masino</b>	Füße Höhen	Pieds Hauteurs	Feet Heights	20, 25
<b>Kulm</b>	Kopfteil	Tête de lit	Headboard	140, 160, 180, 200

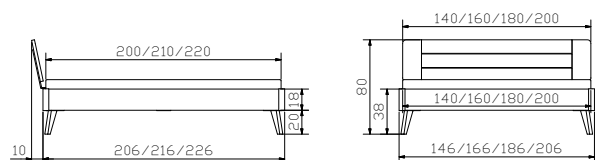



Surf anthracit

Nachttisch

Table de nuit

Bedside table

**Dimension cm**

48/38/36



**Alle Holzteile in Wildeiche natur, geölt** | Toutes les parties en bois en chêne nouveau naturel, huilé | All wooden parts in wildoak natural, oiled

**Weitere Beimöbel siehe Gesamtkatalog Register 2** | Autres accessoires voir catalogue général registre 2 | Further accessories see general catalogue index 2



				<b>Dimension cm</b>
<b>Lounge 18</b>	Rahmen Breiten Längen	Cadre Largeurs Longueurs	Frame Widths Lengths	140, 160, 180, 200 200, 210, 220
<b>Glyn anthracit</b>	Kufen Breiten Höhen	Patins Largeurs Hauteurs	Vats Widths Heights	140, 160, 180, 200 20, 25
<b>Comfy</b>	Kopfteil Kul smoke 336	Tête de lit Kul smoke 336	Headboard Kul smoke 336	140, 160, 180, 200

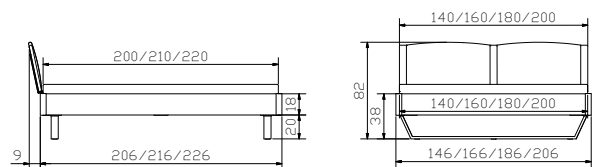



**MOVIE-/TOP LINE**



**FACTORY LINE**



**WOOD LINE**



**LOUNGE**



**FINE LINE**



**NATURO LINE**



**OAK LINE**



**OAK WILD**



**DREAM LINE**



**EDITION  
BOXSPRING**



**FUNCTION/COMFORT  
KIDS & GUESTS**



**LATTENROSTE &  
MATRATZEN**



**Gesamtkatalog**  
Catalogue général  
General catalogue