



swiss bed concept



OAKLINE/BIANCO

EICHE MASSIV | CHÊNE MASSIF | SOLID OAK

Achten Sie auf FSC®-zertifizierte Produkte | Soyez attentifs aux produits certifiés FSC® | Look for FSC®-certified products

Hasena – mein Bett

Hasena – mon lit | Hasena – my bed

Beständige Passion

Une passion constante
Enduring Passion

Mehr als ein Lebenswerk

Seit 1951 überzeugen wir mit hoher Qualität und Vielseitigkeit im Bereich Schlafzimmermöbel.

Plus que l'œuvre d'une vie

Depuis 1951, nous convainquons par notre qualité élevée et notre polyvalence dans le domaine des meubles de chambre à coucher.

More than a life's work

Since 1951 we have been convincing with high quality and versatility in the bedroom furniture sector.



swiss bed concept



swiss bed concept

Ein cleveres Baukastensystem

Sie wählen Ihren favorisierten Bettrahmen aus und kombinieren dazu Füße und Kopfteil Ihrer Wahl. Dabei können Sie quer durch die Kollektionen auf unterschiedliche Materialien und Farben zugreifen.

Un système modulaire astucieux

Choisissez votre cadre de lit préféré et combinez-le avec les pieds et la tête de lit de votre choix. Vous pouvez choisir parmi une variété de matériaux et de couleurs dans toutes les collections.

A clever modular system

You choose your favourite bed frame and combine it with the feet and headboard of your choice. You can choose from a variety of materials and colours throughout the collections.

5 Jahre Garantie

5 ans de garantie
5 years warranty



Unser Versprechen

Vom Baum zum Bett – mittels handwerklicher Perfektion und hochwertigen Materialien. Sie erhalten 5 Jahre Garantie auf die Material- und Oberflächenbeschaffenheit, sowie die fachgerechte Verarbeitung aller Modelle ab Kaufdatum. Weitere Informationen finden Sie auf unserer Website.

Notre promesse

De l'arbre au lit – grâce à un artisanat parfait et des matériaux de haute qualité. Vous bénéficiez d'une garantie de 5 ans sur la qualité des matériaux et des surfaces, ainsi que sur la fabrication professionnelle de tous les modèles à compter de la date d'achat. Vous trouverez plus d'informations sur notre site Internet.

Our promise

From tree to bed – by means of perfect craftsmanship and high-quality materials. You receive a 5-year guarantee on the material and surface quality, as well as the professional workmanship of all models from the date of purchase. Further information can be found on our website.

Schnellieferservice

Service de livraison rapide
Quick delivery service



Komfort ohne Wartezeit

Mit unserem Schnellieferservice «PRONTO» können wir eine grosse Auswahl an Betten mit Beimöbeln und alle Modelle aus Edition pronto, Dream pronto und Boxspring pronto ab Lager liefern.

Le confort sans délai d'attente

Notre service de livraison rapide « PRONTO » permet de livrer un large choix de lits, de meubles d'appoint et tous les modèles de l'Édition Pronto, Dream pronto et Boxspring Pronto à partir du stock.

Comfort without waiting

With our „PRONTO“ fast delivery service, we can deliver a large selection of beds with ancillary furniture and all models from Edition pronto, Dream pronto and Boxspring pronto from stock.



Mehr über Hasena

En savoir plus sur Hasena
More about Hasena



Vielseitig kombinierbar

Unser ausgeklügeltes Baukastensystem «swiss bed concept» bietet eine riesige Auswahl an Füßen, Kopfteilen und Beimöbeln. Darüber hinaus umfasst es verschiedene Stoff-, Kunstleder- und Lederbezüge sowie diverse Holz- und Metallausführungen. Abgestimmte Lattenroste und Matratzen komplettieren unsere Betten zur Wohlfühloase.

Combinable à souhait

Notre système modulaire sophistiqué «swiss bed concept» propose un large choix de pieds, têtes de lits et accessoires. Par ailleurs il comporte différents tissus, cuirs synthétiques et véritables, ainsi que diverses variantes de bois et métal. Des sommiers à lattes et des matelas adaptés complètent nos lits pour un espace bien-être.

Versatile combinable

Our ingenious modular system «swiss bed concept» offers a huge selection of feet, headboards and accessories. In addition, it includes different fabrics, synthetic leather and real leather covers and different wood and metal versions. Matching slatted frames and mattresses complete our beds to an oasis of well-being.

Nachhaltigkeit bei Hasena

Unser wichtigster Lieferant, die Natur, ist sensibel und benötigt lange Regenerationszeiten bei Überbeanspruchung. Wir respektieren die von uns genutzten Ökosysteme und stellen unsere Produkte nachhaltig und mit hohem sozialen Engagement her.



Soziale Verantwortung

Responsabilité sociale
Social responsibility



Holzoberflächen

Surfaces en bois
Wood surfaces



Stabil im Aufbau

Unsere Betten überzeugen durch eine hohe Stabilität. Mittels Einsatz verschiedener Traversen ist eine gesamthafte Belastung von 300 bis 450 kg, inklusive Lattenroste und Matratzen, möglich.

Construction robuste

Nos lits sont convainçants par leur grande stabilité. En utilisant différentes traverses, une charge totale de 300 à 450 kg, y compris sommiers et matelas, est possible.

Solid in construction

Our beds convince with their high stability. By using different trusses, a total load of 300 to 450 kg, including slatted frames and mattresses, is possible.

Durabilité chez Hasena

Notre fournisseur le plus important, la nature, est sensible et nécessite un long temps de régénération en cas de surutilisation. Nous respectons les écosystèmes que nous utilisons et fabriquons nos produits de manière durable et avec un haut niveau d'engagement social.



Holzbeschaffung

Approvisionnement en bois
Wood procurement



Recycelte Stoffe

Tissus recyclés
Recycled fabrics



Einfach in der Montage

Unser Betten-System begeistert durch einen einfachen Aufbau mit leicht verständlicher Montageanleitung sowie hochwertigen Verbindungselementen, welche einen vielfachen Ab- und Wiederaufbau ermöglichen.

Montage facile

Notre système de lits séduit par un montage facile grâce aux instructions aisément compréhensibles ainsi que par les éléments de fixation haut de gamme permettant de monter et démonter les lits à de nombreuses reprises.

Easy to install

Our bed system impresses with its simple, easy-to-understand assembly instructions and high-quality connecting elements, which enable multiple dismantling and reassembly.

Sustainability at Hasena

Our most important supplier, nature, is sensitive and needs long regeneration times in case of overuse. We respect the ecosystems we use and manufacture our products sustainably and with a high level of social commitment.



Produktion Massivholz

Production bois massif
Manufacturing solid wood



Energiegewinnung

Production énergétique
Production of energy





OAK LINE

EICHE MASSIV | CHÊNE MASSIF | SOLID OAK



Bettrahmen | Cadre de lit | Bedframe

Modul 18

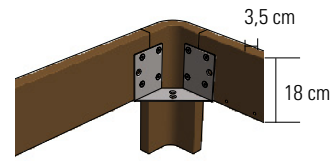

Breiten | Largeurs | Widths:
90, 100, 120, 140, 160, 180, 200 cm

Längen | Longueurs | Lengths:
190, 200, 210, 220 cm

Einlegetiefe | Hauteur encastrable | Insertion depth:
18 cm

Traversen | Traverses | Bars

Wir empfehlen grundsätzlich den Einsatz von Crosstraver (Quertraverse) oder Midtraver (Längstraverse).

Nous recommandons en général l'utilisation de Crosstraver (traverse transversale) ou Midtraver (traverse centrale).

We recommend basically the insertion of Crosstraver (central cross bar) or Midtraver (central bar).

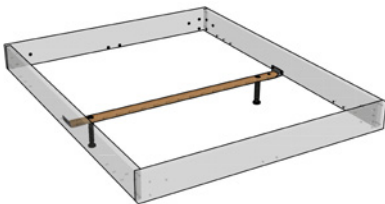

Crosstraver

Quertraverse | Traverse transversale | Central cross bar

Für alle Bettbreiten | Pour toutes les largeurs de lit | For all bed widths

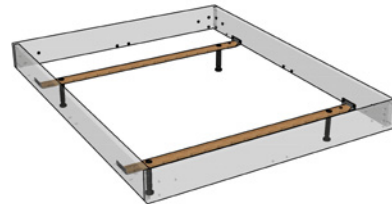

Crosstraver-Twin

Quertraversen | Traverses transversales | Cross bars

Für alle Bettbreiten | Pour toutes les largeurs de lit | For all bed widths

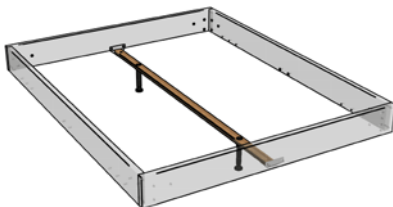

Midtraver

Längstraverse | Traverse centrale | Central bar

Für Betten ab Breite 140 cm mit 2 Lattenrosten oder Motorrahmen-einbau | Pour les lits à partir de 140 cm de largeur avec 2 sommiers ou l'installation d'un cadre motorisé | For beds from 140 cm width with 2 slats or motor frame installation

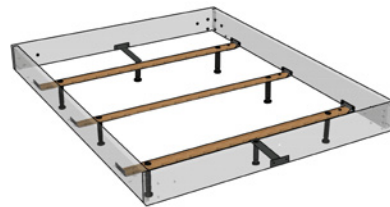

Crosstraver-XXL

Quertraversen | Traverses transversales | Cross bars

Für alle Bettbreiten | Pour toutes les largeurs de lit | For all bed widths

Übersicht Kompatibilität Traversen siehe Gesamtkatalog Seite 2.12 | Aperçu compatibilité traverses voir catalogue général page 2.12 | Overview compatibility bars see general catalogue page 2.12

Ausführungen | Exécutions | Executions

Holz | Bois | Wood

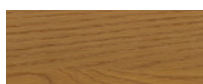

86

Eiche natur, gebürstet, geölt

Chêne naturel, brossé, huilé
Oak natural, brushed, oiled



89

Eiche graphit, gebürstet, geölt

Chêne graphit, brossé, huilé
Oak graphite, brushed, oiled

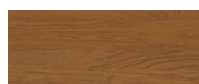

91

Eiche cognac, gebürstet, geölt

Chêne cognac, brossé, huilé
Oak cognac, brushed, oiled

Füsse | Pieds | Feet

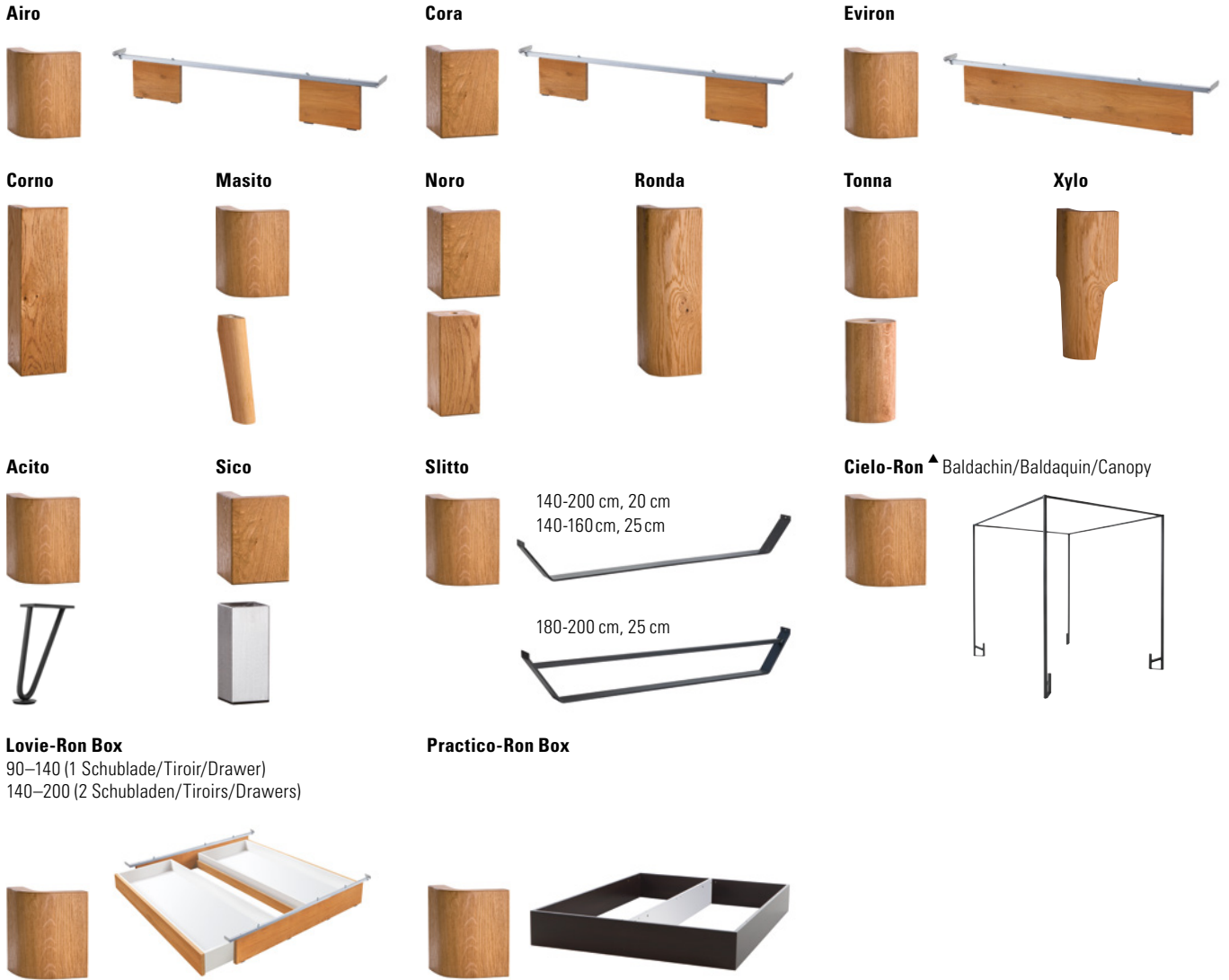

Holz | Bois | Wood

	Breiten cm Largeurs cm Widths cm	Höhen cm Hauteurs cm Heights cm			Holzfarben Couleurs bois Colours wood				
		20	25	30	10	16	86	89	91
Airo	90-200	●					●	●	●
Cora	90-200	●					●	●	●
Corno		●	●	●			●	●	●
Eviron	90-200		●		●	●	●	●	●
Lovie-Ron Box (1 Schublade/Tiroir/Drawer)	90-140		●		●	●	●	●	●
Lovie-Ron Box (2 Schubladen/Tiroirs/Drawers)	140-200		●		●	●	●	●	●
Masito		●	●				●	●	●
Noro		●	●	●			●	●	●
Practico-Ron Box*	90-200		●		●	●	●	●	●
Ronda		●	●	●			●	●	●
Tonna		●	●	●			●	●	●
Xylo		●	●	●			●	●	●

Metall | Métal | Metal

	Breiten cm Largeurs cm Widths cm	Höhen cm Hauteurs cm Heights cm			Metallfarben Couleurs métal Colours metal			
		20	25	30	10	16	42	43
Acito		●					●	
Cielo-Ron [▲]	120-200	●			●	●		
Sico		●	●	●				●
Slitto	140-200	●	●		●	●	●	

[▲] **Curty Vorhang und Vela Baldachin-Tuch siehe Gesamtkatalog Register 2, Seite 2.7** | Curty rideau et Vela tissu de baldaquin voir catalogue général registre 2, page 2.7 | Curty curtain and Vela canopy cloth see general catalogue index 2, page 2.7

Eckfüsse/Eckteile + Füße (inkl. Beschläge) | Pieds d'angles/Pièces d'angles + Pieds (Visserie incl.) | Corner feet, Corner pieces + Feet (Fittings included)

***weiss/anthrazit = MDF**
*blanc/anthracite = MDF
*white/anthracite = MDF

Metall | Métal | Metal



10 Weiss | Blanc | White

16 Anthracit

42 Alu

43 Inox

Kopfteile | Têtes de lit | Headboards

Alpa



Dimension: 140, 160, 180, 200

Soleo



Dimension: 140, 160, 180, 200

Lisio



Dimension: 90/100, 120, 140, 160, 180, 200

Varus



Dimension: 90/100, 120, 140, 160, 180, 200

gepolstert | rembourrées | upholstered

Cemoa



Dimension: 90, 100, 120, 140, 160, 180, 200 (90–120 = 1 Kissen | Coussin | Cushion)

Gewünschte Liegefläche (Länge)	= zu bestellende Bettrahmenlänge
Surface de couchage souhaitée (Longueur)	= longueur de cadre de lit à commander
Desired mattress lying area (Length)	= length of bedframe to be ordered
190	= 200
200	= 210
210	= 220

Nur montierbar mit runden Ecken. | Montage uniquement possible avec des angles ronds. | Can only be assembled with round edges. (Füsse | Pieds | Feet: Airo, Eviron, Masito, Practico-Ron Box, Ronda, Slitto, Tonna, Xylo, Cielo-Ron, Lovie-Ron Box).

Das Kopfteil Cemoa enthält in Echtleder keine Teilungsnähte.

En cuir véritable, la tête de lit Cemoa ne comporte pas de coutures de séparation. The Cemoa headboard contains no dividing seams in genuine leather.

Adapter | Adaptateur | Adapter

Bei hohen Matratzen kann mit dem Verlängerungsadapter das Kopfteil um 9 oder 13 cm erhöht werden.

La tête de lit peut être rehaussée de 9 ou 13 cm avec l'adaptateur lorsque le matelas est plus épais. With the extension adapter the headboard can be extended 9 or 13 cm if mattresses are high.

Head-Plus Metall | Métal | Metal



black

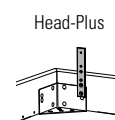
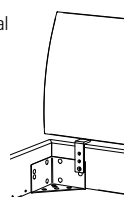

↑
+9 / +13 cm

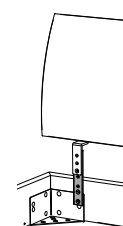

Kissen zu Kopfteilen | Coussins pour têtes de lit | Cushions for headboards

Arona + Alpa



Lumo + Alpa



Ravo + Varus



Sano + Alpa



Suny + Varus



Varo + Varus



Befestigung mit 2 Bändern (Klettverschluss)

Fixation avec 2 bandes Velcro®
Fixation with 2 ribbons (Velcro®fastener)

Kissen | Coussins | Cushions

Effektive Masse cm
Dimensions effectives cm
Effective dimensions cm

zu Kopfteilen
pour têtes de lit
for headboards

Breitenmasse cm
Dimensions de largeur cm
Widths dimensions cm

	Effektive Masse cm Dimensions effectives cm Effective dimensions cm	zu Kopfteilen pour têtes de lit for headboards		Breitenmasse cm Dimensions de largeur cm Widths dimensions cm
		Alpa	Varus	
Arona	86, 116, 136, 156, 176×3,5×25	●		140, 160, 180/200
Lumo	86, 116, 136, 156, 176×6×25	●		140, 160, 180/200
Ravo	80, 110, 130, 150, 170, 190×3,5×35	●	●	90/100, 120, 140, 160, 180, 200
Sano (2er Set set de 2 set of 2)	55×4×35	●		
Suny (2er Set set de 2 set of 2)	55×6×40	●	●	
Varo (2er Set set de 2 set of 2)	55×10×35		●	

Alle Kissen in Echtleder haben Zier- sowie Teilungsnähte. Ausnahmen: Ravo, Suny und Varo, diese Kissen haben lediglich Ziernähte. | Tous les coussins en cuir véritable ont des coutures décoratives et des coutures de séparation. A l'exception des coussins : Ravo, Suny et Varo, ces coussins ont uniquement des coutures décoratives. | All cushions in genuine leather have decorative and dividing seams. Exceptions: Ravo, Suny and Varo, these cushions only have decorative seams.

Ausführungen | Exécutions | Executions

Holz | Bois | Wood

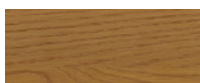

86
Eiche natur, gebürstet, geölt
Chêne naturel, brossé, huilé
Oak natural, brushed, oiled



89
Eiche graphit, gebürstet, geölt
Chêne graphit, brossé, huilé
Oak graphit, brushed, oiled

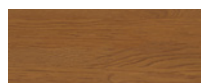

91
Eiche cognac, gebürstet, geölt
Chêne cognac, brossé, huilé
Oak cognac, brushed, oiled

selezione

01

MODELLAUSWAHL

Sélection du modèle | Model selection

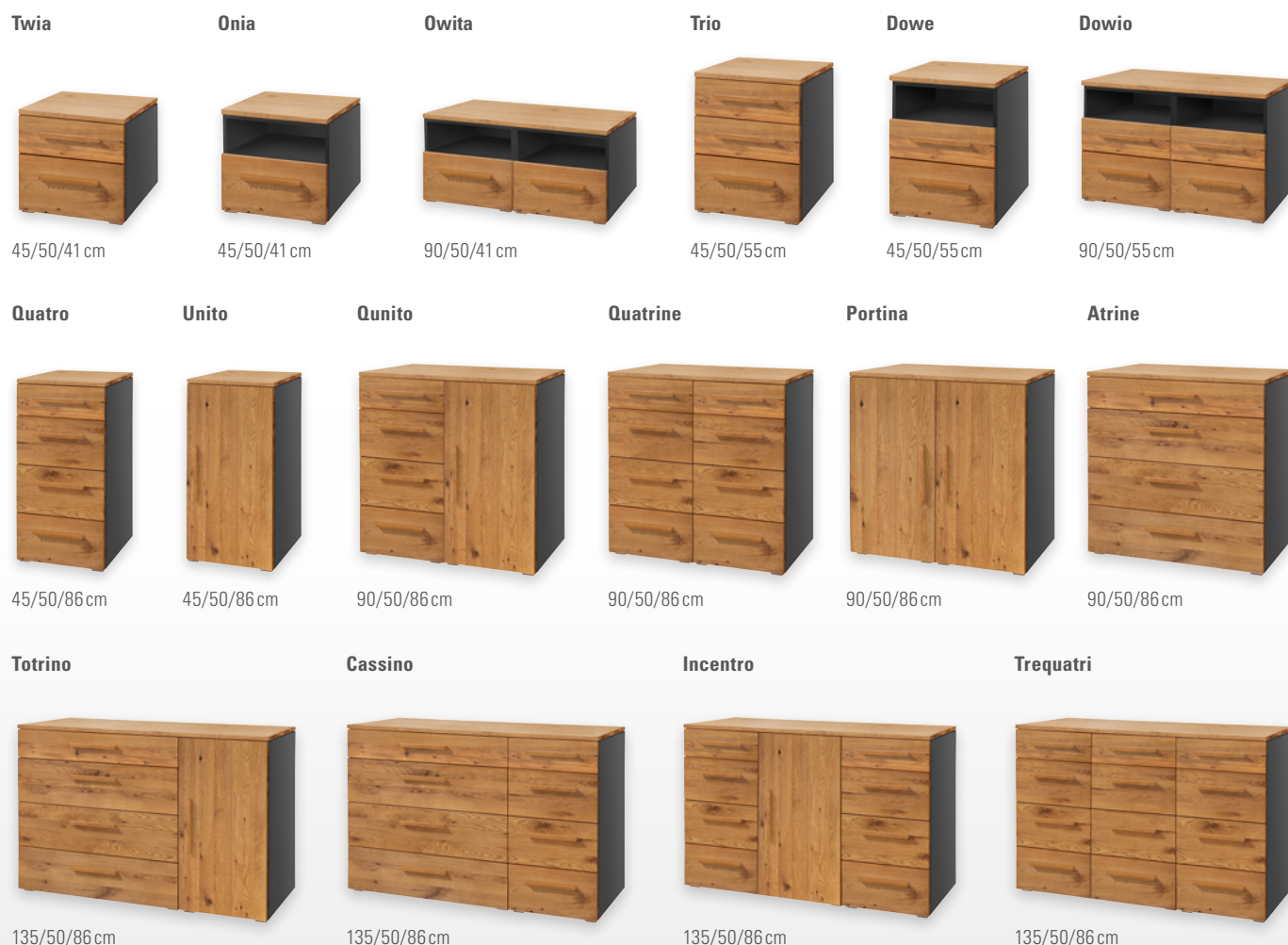
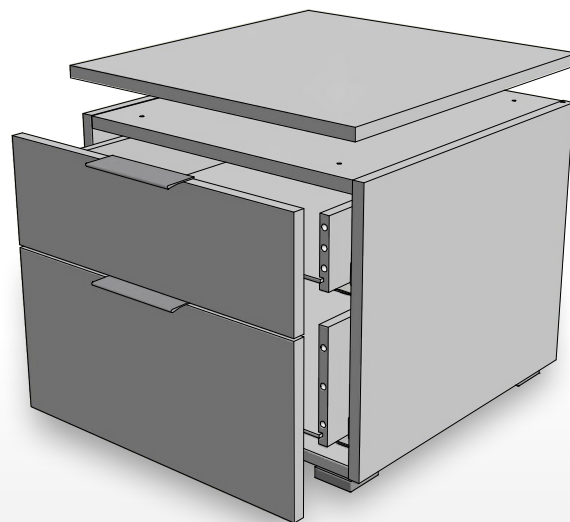

Stellen Sie sich Ihr Wunsch-Beimöbel nach Ihrem Geschmack zusammen: Der Korpus (Abb. 02), in zwei verschiedenen Farbvarianten, lässt sich zu den Front- und Top-Covern (Abb. 03) in acht Holz- und Farbausführungen kombinieren. Die Beimöbel können zerlegt oder teilmontiert bestellt werden. Bei zusammengesetzten Möbeln (z. B. Qunito, Incentro, ...) muss der Deckel noch montiert werden. Bei Kommoden mit Türen ist jeweils ein Einlegeboden vorhanden, Türöffnung nach links oder rechts möglich. Zusätzliche Böden sind erhältlich.

Composez le meuble d'appoint de vos rêves selon vos goûts : Le caisson (ill. 02), disponible en 2 variantes de couleurs, peut être combiné avec les façades et couvercles supérieurs (ill. 03) en 8 finitions de bois et de coloris. Les meubles d'appoint peuvent être commandés en kits ou assemblés. Pour les meubles assemblés (p. ex. Qunito, Incentro, ...) le couvercle doit encore être fixé. Les commodes avec portes sont équipées d'une étagère, ouverture de la porte possible à gauche ou à droite. Si besoin, des étagères supplémentaires sont disponibles.

Put together the side furniture you want according to your own taste: The body (fig. 02), in two different colour versions, can be combined with the front and top covers (fig. 03) in eight wood and colour versions. The furniture can be ordered disassembled or assembled. For assembled furniture (e.g. Qunito, Incentro, ...) the top cover must still be fitted. Chests of drawers with doors have one shelf, door opening possible to the left or right. Additional shelves are available.



Kombinationsbeispiele und techn. Informationen
Exemples et informations
Examples and informations

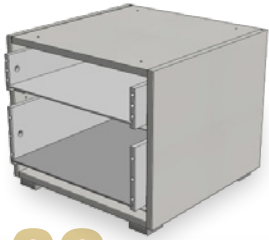

02

KORPUS

Caisson | Body



03

TOP/FRONT

Farben | Couleurs | Colours

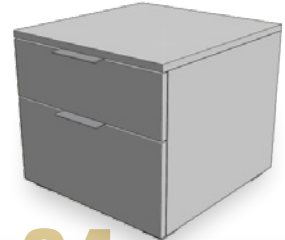

04

GRIFFE

Poignées | Handles



10 Weiss | Blanc | White



16 Anthracit | Anthracite



FÜSSE

Pieds | Feet

STANDARD



OPTION

Leg 8 cm



Alu

Jone 10 cm



Anthracit
Used

Cila 10 cm



Anthracit



10 Weiss | Blanc | White



16 Anthracit | Anthracite

STANDARD



Alu

Griff zu Folienfronten

Poignée pour façades en mélaminé
Handle for foil fronts

STANDARD



Holzgriff zu Holzfronten

Poignée en bois pour façades en bois
Wooden handle for wooden fronts

OPTION

Rivo



Used



Anthracit

Metallgriff zu Holzfronten

Poignée en métal pour façades en bois
Metal handle for wooden fronts

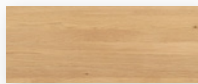

74 Eiche bright, geölt
Chêne bright, huilé
Oak bright, oiled

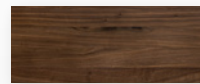

82 Nussbaum, geölt
Noyer, huilé
Walnut, oiled

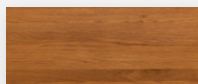

76 Eiche brandy, geölt
Chêne brandy, huilé
Oak brandy, oiled

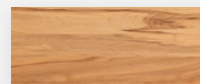

87 Wildbuche natur, geölt
Hêtre nouveau naturel, huilé
Wildbeech natural, oiled

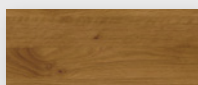

99 Wildeiche natur, geölt
Chêne nouveau naturel, huilé
Wildoak natural, oiled



80 Kernbuche natur, geölt
Hêtre coeur rouge naturel, huilé
Heart beech natural, oiled



The mark of
responsible forestry
FSC® C123546

Look for FSC® certified products



				Dimension cm
Totrino	Kommode	Commode	Chest of drawers	135/50/86
Twia	Nachttisch	Table de nuit	Bedside table	45/50/41
Sola	Bank	Table de nuit	Bedside table	140/37/38
Vano	Kissen, Campos blanc 372	Coussin, Campos blanc 372	Cushion, Campos blanc 372	136/34/3

Alle Holzteile in Eiche cognac, gebürstet, geölt und weiss | Toutes les parties en bois en chêne cognac, brossé, huilé et blanc | All wooden parts in oak cognac, brushed, oiled and white

Weitere Beimöbel siehe Gesamtkatalog Register 2 | Autres accessoires voir catalogue général registre 2 | Further accessories see general catalogue index 2



				Dimension cm
Modul 18	Rahmen Breiten Längen	Cadre Largeurs Longueurs	Frame Widths Lengths	140, 160, 180, 200 190, 200, 210, 220
Masito	Füße, Eckteile Höhen	Pieds, Pièces d'angles Hauteurs	Feet, Corner pieces Heights	20, 25
Soleo	Kopfteil	Tête de lit	Headboard	140, 160, 180, 200

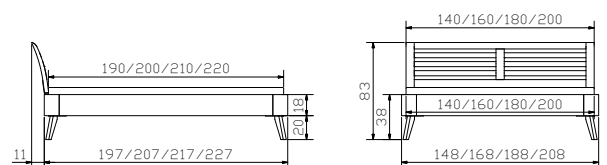



				Dimension cm
Modul 18	Rahmen Breiten Längen	Cadre Largeurs Longueurs	Frame Widths Lengths	90, 100, 120, 140, 160, 180, 200 190, 200, 210, 220
Xylo	Eckfüsse Höhen	Pieds d'angles Hauteurs	Corner feet Heights	20(38), 25(43), 30(48)
Gabo	Kopfteil, Campos blanc 372 siehe Gesamtkatalog Register 1	Tête de lit, Campos blanc 372 voir catalogue général registre 1	Headboard, Campos blanc 372 see general catalogue index 1	90, 100, 120, 140, 160, 180, 200

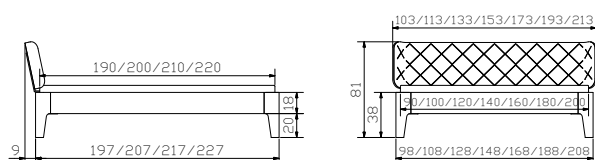

Alle Holzteile in Eiche natur, gebürstet, geölt

Toutes les parties en bois en chêne naturel, brossé, huilé
All wooden parts in oak natural, brushed, oiled

Weitere Beimöbel siehe Gesamtkatalog Register 2

Autres accessoires voir catalogue général registre 2
Further accessories see general catalogue index 2



				Dimension cm
Modul 18	Rahmen Breiten Längen	Cadre Largeurs Longueurs	Frame Widths Lengths	90, 100, 120, 140, 160, 180, 200 190, 200, 210, 220
Xylo	Eckfüsse Höhen	Pieds d'angles Hauteurs	Corner feet Heights	20(38), 25(43), 30(48)
Lisio	Kopfteil	Tête de lit	Headboard	90/100, 120, 140, 160, 180, 200
Koro	Nachttisch	Table de nuit	Bedside table	50/40/57

Alle Holzteile in Eiche cognac, gebürstet, geölt

Toutes les parties en bois en chêne cognac, brossé, huilé
All wooden parts in oak cognac, brushed, oiled

Weitere Beimöbel siehe Gesamtkatalog Register 2

Autres accessoires voir catalogue général registre 2
Further accessories see general catalogue index 2

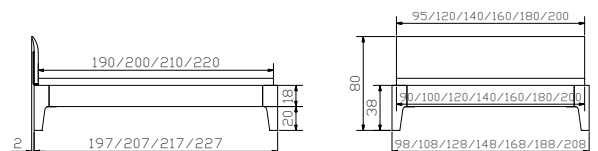



				Dimension cm
Sola	Bank	Banquette	Bench	140/37/38
Topia	Kissen, Campos blanc 372	Coussin, Campos blanc 372	Cushion, Campos blanc 372	140/37/10
Cara	Nachttisch	Table de nuit	Bedside table	50/40/40
Vela	Baldachin-Tuch, Baumwolle weiss	Tissu de baldaquin, Coton blanc	Canopy cloth, Cotton white	
	Breiten	Largeurs	Widths	120, 140, 160, 180, 200
	Länge	Longueur	Length	200
Curty	Baldachin-Vorhang (3er Set)	Rideau de baldaquin (set de 3)	Curtain of canopy (set of 3)	272/185 (3x)
	Baumwolle weiss	Coton blanc	Cotton white	





				Dimension cm
Modul 18	Rahmen Breiten Längen	Cadre Largeurs Longueurs	Frame Widths Lengths	120, 140, 160, 180, 200 190, 200, 210, 220
Cielo-Ron white	Baldachin Breiten Längen Höhe	Baldaquin Largeurs Longueurs Hauteur	Canopy Widths Lengths Height	120, 140, 160, 180, 200 200, 210, 220 20
Ripo	Kopfteil, Campos blanc 372	Tête de lit, Campos blanc 372	Headboard, Campos blanc 372	120, 140, 160, 180, 200

Alle Holzteile in Eiche natur, gebürstet, geölt

Toutes les parties en bois en chêne naturel, brossé, huilé
All wooden parts in oak natural, brushed, oiled

Weitere Beimöbel siehe Gesamtkatalog Register 2

Autres accessoires voir catalogue général registre 2
Further accessories see general catalogue index 2

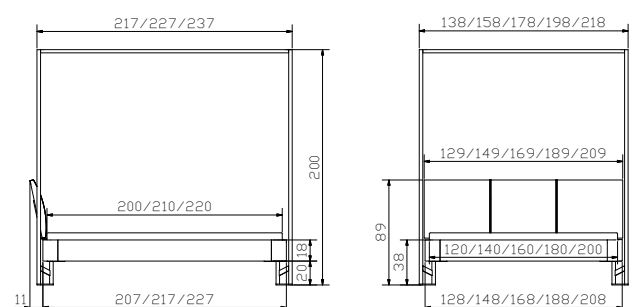



	Dimension cm			
Cemoa	Kopfteil, Fusio shell 750 hat Einfluss auf Bettlänge siehe Seite 10.6	Tête de lit, Fusio shell 750 a un impact sur la longueur du lit voir page 10.6	Headboard, Fusio shell 750 affects the length of bed see 10.6	90, 100, 120, 140, 160, 180, 200 90 – 120 = 1 Kissen/Coussin/ Cushion
Boga	Kopfteil, Fusio shell 750 siehe Gesamtkatalog Register 1	Tête de lit, Fusio shell 750 voir catalogue général registre 1	Headboard, Fusio shell 750 see general catalogue index 1	90, 100, 120, 140, 160, 180, 200

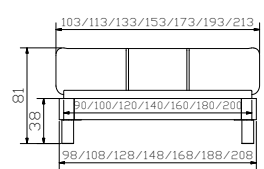
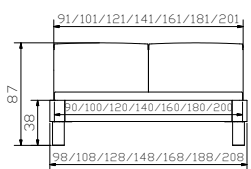



				Dimension cm
Modul 18	Rahmen Breiten Längen	Cadre Largeurs Longueurs	Frame Widths Lengths	90, 100, 120, 140, 160, 180, 200 190(200), 200(210), 210(220)
Slitto white	Kufen, Eckteile Breiten Höhen	Patins, Pièces d'angles Largeurs Hauteurs	Vats, Corner pieces Widths Heights	140, 160, 180, 200 20, 25
Cemoa	Kopfteil, Campos blanc 372 hat Einfluss auf Bettlänge siehe Seite 8	Tête de lit, Campos blanc 372 a un impact sur la longueur du lit voir page 8	Headboard, Campos blanc 372 affects the length of bed see page 8	90, 100, 120, 140, 160, 180, 200 90 – 120 = 1 Kissen/Coussin/ Cushion
Aida	Kommode	Commode	Chest of drawers	105/40/75
Cara	Nachttisch	Table de nuit	Bedside table	50/40/40

Alle Holzteile in Eiche natur, gebürstet, geölt

Toutes les parties en bois en chêne naturel, brossé, huilé
All wooden parts in oak natural, brushed, oiled

Weitere Beimöbel siehe Gesamtkatalog Register 2

Autres accessoires voir catalogue général registre 2
Further accessories see general catalogue index 2

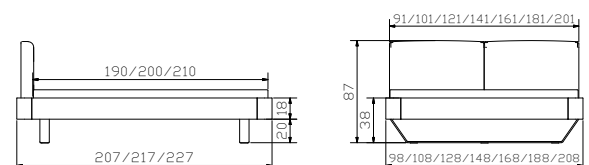



Lovie-Ron Box

1 Bettkasten
Breiten
2 Bettkästen
Breiten
Höhe

1 Tiroir de lit
Largeurs
2 Tiroirs de lit
Largeurs
Hauteur

1 Bed drawer
Widths
2 Bed drawers
Widths
Height

Dimension cm

90, 100, 120, 140
140, 160, 180, 200
25

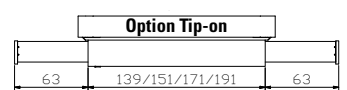
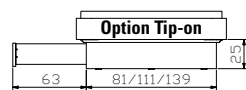
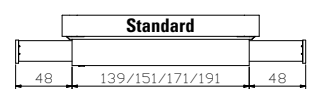
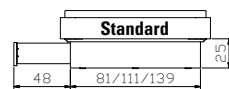



				Dimension cm
Modul 18	Rahmen Breiten Längen	Cadre Largeurs Longueurs	Frame Widths Lengths	140, 160, 180, 200 190, 200, 210, 220
Slitto anthracit	Kufen, Eckteile Breiten Höhen	Patins, Pièces d'angles Largeurs Hauteurs	Vats, corner pieces Widths Heights	140, 160, 180, 200 20, 25
Cussina	Kopfteil, Fusio musk 752 siehe Gesamtkatalog Register 1	Tête de lit, Fusio musk 752 voir catalogue général registre 1	Headboard, Fusio musk 752 see general catalogue index 1	140, 160, 180, 200
Topa anthracit	Bank inkl. Kissen Fusio musk 752	Banquette, Coussin incl. Fusio musk 752	Bench, cushion incl. Fusio musk 752	144/44/38
Caja	Nachttisch	Table de nuit	Bedside table	48/41/16

Alle Holzteile in Eiche graphit, gebürstet, geölt

Toutes les parties en bois en chêne graphit, brossé, huilé
All wooden parts in oak graphit, brushed, oiled

Weitere Beimöbel siehe Gesamtkatalog Register 2

Autres accessoires voir catalogue général registre 2
Further accessories see general catalogue index 2

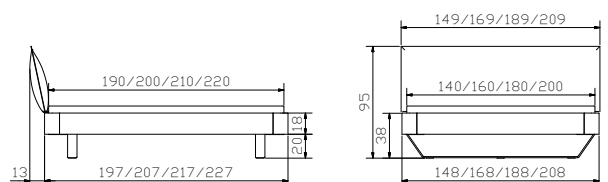



OAK BIANCO

EICHE MASSIV | CHÊNE MASSIF | SOLID OAK



Bettrahmen | Cadre de lit | Bedframe

Modul 18

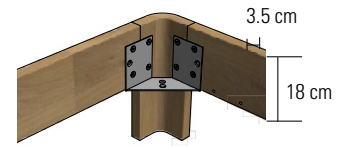

Breiten | Largeurs | Widths:
90, 100, 120, 140, 160, 180, 200 cm

Längen | Longueurs | Lengths:
190, 200, 210, 220 cm

Einlegetiefe | Hauteur encastrable | Insertion depth:
18 cm

Traversen | Traverses | Bars

Wir empfehlen grundsätzlich den Einsatz von Crosstraver (Quertraverse) oder Midtraver (Längstraverse).

Nous recommandons en général l'utilisation de Crosstraver (traverse transversale) ou Midtraver (traverse centrale).

We recommend basically the insertion of Crosstraver (central cross bar) or Midtraver (central bar).

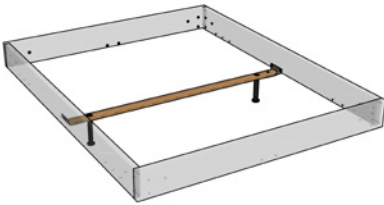

Crosstraver

Quertraverse | Traverse transversale | Central cross bar

Für alle Bettbreiten | Pour toutes les largeurs de lit | For all bed widths

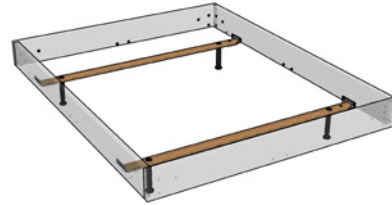

Crosstraver-Twin

Quertraversen | Traverses transversales | Cross bars

Für alle Bettbreiten | Pour toutes les largeurs de lit | For all bed widths

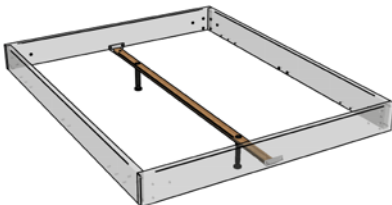

Midtraver

Längstraverse | Traverse centrale | Central bar

Für Betten ab Breite 140 cm mit 2 Lattenrosten oder Motorrahmen-einbau | Pour les lits à partir de 140 cm de largeur avec 2 sommiers ou l'installation d'un cadre motorisé | For beds from 140 cm width with 2 slats or motor frame installation

Übersicht Kompatibilität Traversen siehe Gesamtkatalog Seite 2.12 | Aperçu compatibilité traverses voir catalogue général page 2.12 | Overview compatibility bars see general catalogue page 2.12

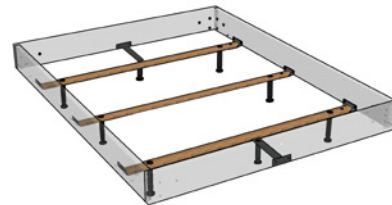

Crosstraver-XXL

Quertraversen | Traverses transversales | Cross bars

Für alle Bettbreiten | Pour toutes les largeurs de lit | For all bed widths

Holz | Bois | Wood



73

Eiche bianco, gebürstet, geölt

Chêne bianco, brossé, huilé

Oak bianco, brushed, oiled

Deklaration der Holzherkunft siehe Gesamtkatalog Einleitungsseiten

Déclaration de l'origine du bois voir catalogue général pages d'introduction

Declaration of wood origin see general catalogue introductory pages

Füsse | Pieds | Feet

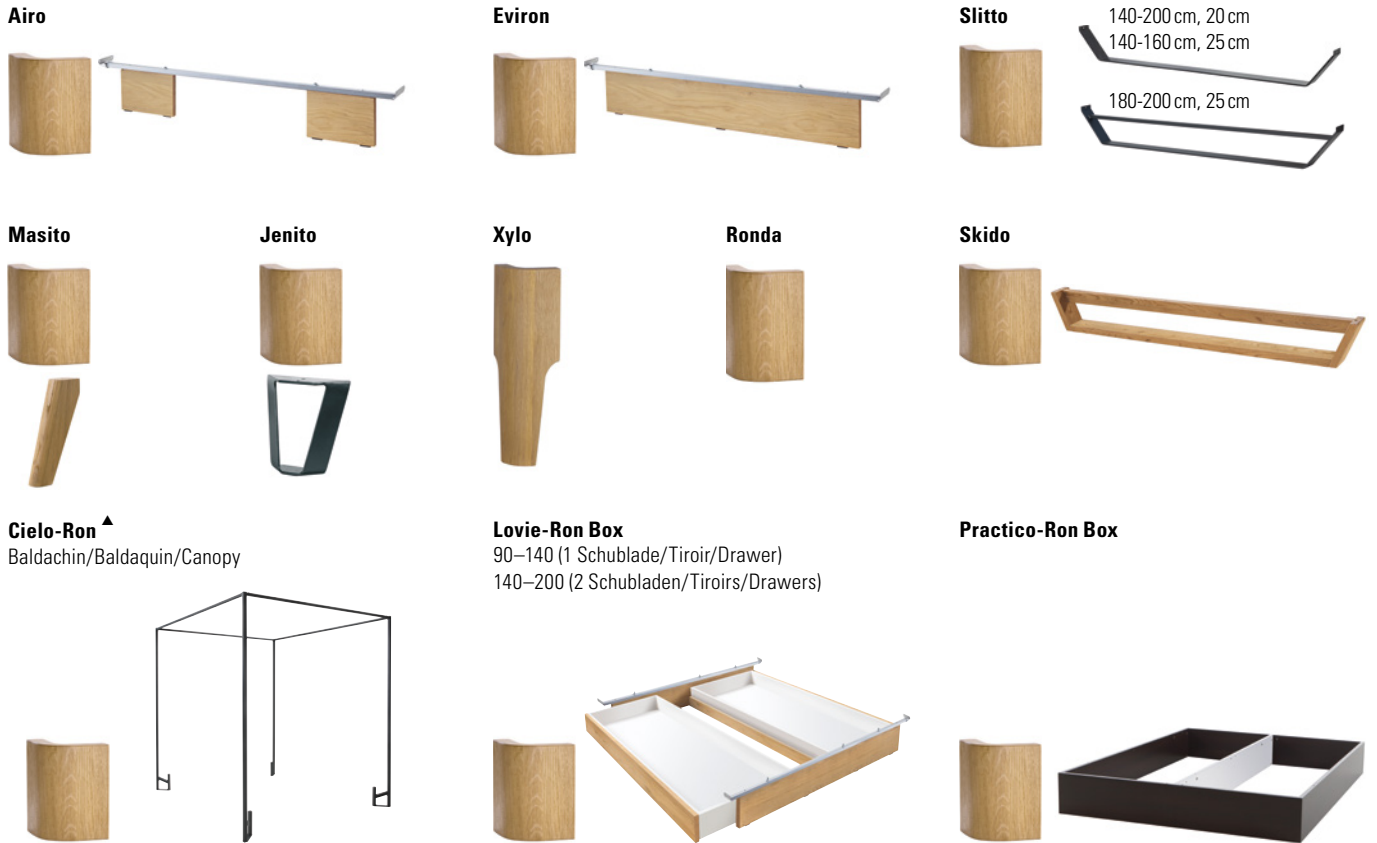

Eckfüsse/Eckteile + Füsse (inkl. Beschläge)
Pieds d'angles/Pièces d'angles + Pieds (Visserie incl.)
Corner feet/Corner pieces + Feet (Fittings included)

	Breiten cm Largeurs cm Widths cm		Höhen cm Hauteurs cm Heights cm			Holzfarben Couleurs bois Colours wood			Metallfarben Couleurs métal Colours metal			
	20	25	30	10	16	73	04	10	16	42		
Airo	90–200	●				●						
Cielo-Ron [▲]	120–200	●				●		●				
Eviron	90–200		●			●						
Lovie-Ron Box (1 Schublade/tiroir/drawer)	90–140		●			●						
Lovie-Ron Box (2 Schubladen/tiroirs/drawers)	140–200		●			●						
Practico-Ron Box* (inkl. Boden fond inclus bottom included)	90–200		●			●	●	●				
Ronda		●	●	●		●						
Jenito		●	●			●	●		●			
Masito		●	●			●						
Slitto	140–200	●	●			●		●	●	●		
Skido			●			●						
Xylo		●	●	●		●						

*weiss/anthrazit = MDF | *blanc/anthracite = MDF | *white/anthracite = MDF

[▲] Curty Vorhang und Vela Baldachin-Tuch siehe Gesamtkatalog Register 2, Seite 2.7 | Curty rideau et Vela tissu de baldaquin voir catalogue général registre 2, page 2.7 | Curty curtain and Vela canopy cloth see general catalogue index 2, page 2.7

Ausführungen | Exécutions | Executions

Metall | Métal | Metal

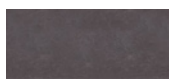

04
used



10
white



16
Anthracit

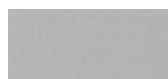

42
Alu

04 Used = Stahl galvanisiert | Acier galvanisé | Steel galvanised

10 White = Stahl pulverbeschichtet | Acier thermolaqué | Steel powder-coated

16 Anthracit = Stahl pulverbeschichtet | Acier thermolaqué |

Steel powder-coated

42 Alu = Stahl pulverbeschichtet | Acier thermolaqué | Steel powder-coated

Kopfteile | Têtes de lit | Headboards

Alpa

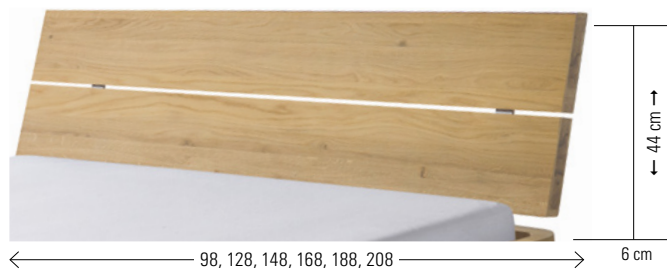

Dimension: 90/100, 120, 140, 160, 180, 200

Varus



Dimension: 140, 160, 180, 200

Edda



Dimension: 90/100, 120, 140, 160, 180, 200

gepolstert | rembourrées | upholstered

*Cemoa



Dimension: 90, 100, 120, 140, 160, 180, 200 (90–120 = 1 Kissen | Coussin | Cushion)

Gewünschte Liegefläche (Länge) = zu bestellende Bettrahmenlänge

Surface de couchage souhaitée (Longueur) = longueur de cadre de lit à commander

Desired mattress lying area (Length) = length of bedframe to be ordered

190 = 200

200 = 210

210 = 220

***Nur montierbar mit runden Ecken.** | Montage uniquement possible avec des angles ronds. | Can only be assembled with round edges.
(Füße | Pieds | Feet: Airo, Eviron, Masito, Jenito, Practico-Ron Box, Ronda, Slitto, Tonna, Xylo, Cielo-Ron, Lovie-Ron Box).

Das Kopfteil Cemoa enthält in Echtleder keine Teilungsnähte.

En cuir véritable, la tête de lit Cemoa ne comporte pas de coutures de séparation.
The Cemoa headboard contains no dividing seams in genuine leather.

Adapter | Adaptateur | Adapter

Bei hohen Matratzen kann mit dem Verlängerungsadapter das Kopfteil um 9 oder 13 cm erhöht werden.

La tête de lit peut être rehaussée de 9 ou 13 cm avec l'adaptateur lorsque le matelas est plus épais.
With the extension adapter the headboard can be extended 9 or 13 cm if mattresses are high.

**Head-Plus
Metall | Métal | Metal**



black

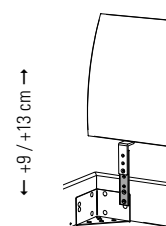
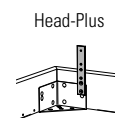
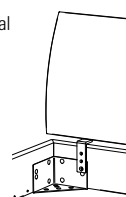

Kissen zu Kopfteilen | Coussins pour têtes de lit | Cushions for headboards

Arona + Alpa



Lumo + Alpa



Ravo + Varus



Sano + Alpa



Suny + Varus



Varo + Varus



Befestigung mit 2 Bändern (Klettverschluss)

Fixation avec 2 bandes (velcro®)
Fixation with 2 ribbons (Velcro® fastener)

Kissen | Coussins | Cushions

Effektive Masse cm

Dimensions effectives cm
Effective dimensions cm

zu Kopfteilen

pour têtes de lit
for headboards

Breitenmasse cm

Dimensions de largeur cm
Widths dimensions cm

	Effektive Masse cm Dimensions effectives cm Effective dimensions cm	zu Kopfteilen pour têtes de lit for headboards		Breitenmasse cm Dimensions de largeur cm Widths dimensions cm
		Alpa	Varus	
Arona	86, 116, 136, 156, 176×3,5×25	●		90/100, 120, 140, 160, 180/200
Lumo	86, 116, 136, 156, 176×6×25	●		90/100, 120, 140, 160, 180/200
Ravo	80, 110, 130, 150, 170, 190×3,5×35	●	●	90/100, 120, 140, 160, 180, 200
Sano (2er Set set de 2 set of 2)	55×4×35	●		
Suny (2er Set set de 2 set of 2)	55×6×40	●	●	
Varo (2er Set set de 2 set of 2)	55×10×35		●	

Alle Kissen in Echtleder haben Zier- sowie Teilungsnähte. Ausnahmen: Ravo, Suny und Varo, diese Kissen haben lediglich Ziernähte. | Tous les coussins en cuir véritable ont des coutures décoratives et des coutures de séparation. A l'exception des coussins : Ravo, Suny et Varo, ces coussins ont uniquement des coutures décoratives. | All cushions in genuine leather have decorative and dividing seams. Exceptions: Ravo, Suny and Varo, these cushions only have decorative seams.



Gepolsterte Kopfteile, Wandpaneele, Stoffauswahl/Farben siehe Gesamtkatalog Register 1, Leselampen siehe Gesamtkatalog Register 2.

Têtes de lits rembourrées, panneaux muraux, choix de tissus/couleurs voir catalogue général registre 1, lampes de lecture voir registre 2.

Upholstered headboards, wallpanels, choice of tissues/colours see general catalogue index 1, reading lamps see general index 2.



				Dimension cm
Portina	Kommode	Commode	Chest of drawers	90/50/96
Dowe	Nachttisch	Table de nuit	Bedside table	45/50/55
Sola	Bank	Banquette	Bench	140/37/38
Claudio alu	Herrendiener	Valet	Dressboy	45/28/107

Alle Holzteile in Eiche bianco, gebürstet, geölt | Toutes les parties en bois en chêne bianco, brossé, huilé | All wooden parts in oak bianco, brushed, oiled

Portina, Dowe: Eiche bright, geölt und anthracit | Chêne bright, huilé et anthracite | Oak bright, oiled and anthracite

Weitere Beimöbel siehe Gesamtkatalog Register 2 | Autres accessoires voir catalogue général registre 2 | Further accessories see general catalogue index 2



				Dimension cm
Modul 18	Rahmen Breiten Längen	Cadre Largeurs Longueurs	Frame Widths Lengths	140, 160, 180, 200 190, 200, 210, 220
Skido	Kufen, Eckteile Breiten Höhe	Patins, Pièces d'angles Largeurs Hauteur	Vats, Corner pieces Widths Height	140, 160, 180, 200 25
Varus	Kopfteil	Tête de lit	Headboard	140, 160, 180, 200
Ravo	Kissen, Boucle mouse 773	Coussin, Boucle mouse 773	Cushion, Boucle mouse 773	140, 160, 180, 200

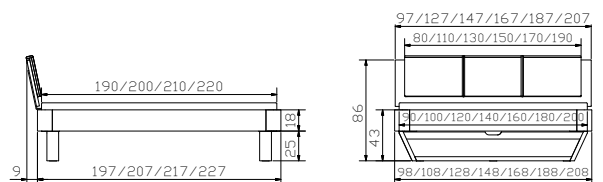



				Dimension cm
Atrine	Kommode siehe Gesamtkatalog Register 2	Commode voir catalogue général registre 2	Chest of drawers see general catalogue index 2	90/50/86
Onia	Nachttisch siehe Gesamtkatalog Register 2	Table de nuit voir catalogue général registre 2	Bedside table see general catalogue index 2	45/50/41
Sola Topia	Bank Kissen, Fusio shell 750	Banquette Coussin, Fusio shell 750	Bench Cushion, Fusio shell 750	140/37/38

Alle Holzteile in Eiche bianco, gebürstet, geölt oder Eiche bright, geölt | Toutes les parties en bois en chêne bianco, brossé, huilé ou chêne bright, huilé | All wooden parts in oak bianco, brushed, oiled or oak bright, oiled

Atrine, Onia: Eiche bright, geölt und weiss | Chêne bright, huilé et blanc | Oak bright, oiled and white

Weitere Beimöbel siehe Gesamtkatalog Register 2 | Autres accessoires voir catalogue général registre 2 | Further accessories see general catalogue index 2



				Dimension cm
Modul 18	Rahmen Breiten Längen	Cadre Largeurs Longueurs	Frame Widths Lengths	90, 100, 120, 140, 160, 180, 200 190, 200, 210, 220
Xylo	Eckfüsse Höhen	Pieds d'angles Hauteurs	Corner feet Heights	20(38), 25(43), 30(48)
Elipsa	Kopfteil, Fusio shell 750 siehe Gesamtkatalog Register 1	Tête de lit, Fusio shell 750 voir catalogue général registre 1	Headboard, Fusio shell 750 see general catalogue index 1	90, 100, 120, 140, 160, 180, 200

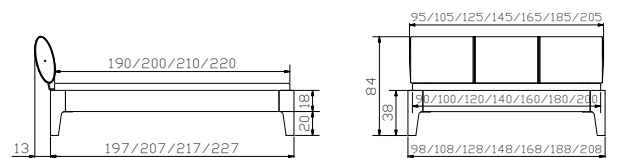



MOVIE-/TOP LINE



FACTORY LINE



WOOD LINE



LOUNGE



FINE LINE



NATURO LINE



OAK LINE



OAK WILD



DREAM LINE



**EDITION
BOXSPRING**



**FUNCTION/COMFORT
KIDS & GUESTS**



**LATTENROSTE &
MATRATZEN**



Gesamtkatalog
Catalogue général
General catalogue